



# **7368 Intelligent Services Access Manager ONT**

## **7368 ISAM ONT G-2425G-A Product Guide**

**3FE-48292-ABAA-TCZZA**

**Issue: 01**

Nokia is a registered trademark of Nokia Corporation. Other products and company names mentioned herein may be trademarks or tradenames of their respective owners.

The information presented is subject to change without notice. No responsibility is assumed for inaccuracies contained herein.

© 2020 Nokia.

Contains proprietary/trade secret information which is the property of Nokia and must not be made available to, or copied or used by anyone outside Nokia without its written authorization. Not to be used or disclosed except in accordance with applicable agreements.

# 1 Preface

This preface provides general information about the documentation set for optical network terminals (ONTs).

## 1.1 Scope

This documentation set provides information about safety, features and functionality, ordering, hardware installation and maintenance, and software installation procedures for the current release.

## 1.2 Audience

This documentation set is intended for planners, administrators, operators, and maintenance personnel involved in installing, upgrading, or maintaining the ONTs.

## 1.3 Required knowledge

The reader must be familiar with general telecommunications principles.

## 1.4 Acronyms and initialisms

The expansions and optional descriptions of most acronyms and initialisms appear in the glossary.

## 1.5 Assistance and ordering phone numbers

Nokia provides global technical support through regional call centers. Phone numbers for the regional call centers are available at the following URL:

<https://customer.nokia.com/support/s>

For ordering information, contact your Nokia sales representative.

---

## 1.6 Nokia quality processes

Nokia's ONT quality practices are in compliance with TL 9000 requirements. These requirements are documented in the Fixed Networks Quality Manual 3FQ-30146-6000-QRZZA. The quality practices adequately ensure that technical requirements and customer end-point requirements are met. The customer or its representatives may be allowed to perform on-site quality surveillance audits, as agreed upon during contract negotiations

## 1.7 Safety information

For safety information, see the appropriate safety guidelines chapter.

## 1.8 Documents

Documents are available using ALED or OLCS.

### Procedure 1 To download a ZIP file package of the customer documentation

- 
- 1 Navigate to <https://customer.nokia.com/support/s> and enter your user name and password. If you are a new user and require access to this service, please contact your Nokia sales representative.

---

  - 2 From the Technical Content for drop-down menu, choose the product.

---

  - 3 Click on Downloads: Electronic Delivery.

---

  - 4 Choose Documentation from the drop-down menu and click Next.

---

  - 5 Select the image from the drop-down menu and click Next.

---

  - 6 Follow the on-screen directions to download the file.

---

---

## Procedure 2 To access individual documents

Individual PDFs of customer documents are also accessible through the Nokia Customer Support website.

- 1 Navigate to <https://customer.nokia.com/support/s> and enter your user name and password. If you are a new user and require access to this service, please contact your Nokia sales representative.
  - 2 From the Technical Content for drop-down menu, choose the product.
  - 3 Click on Manuals and Guides to display a list of customer documents by title and part number. You can filter this list using the Release drop-down menu.
  - 4 Click on the PDF to open or save the file.
- 

## 1.9 Special information

The following are examples of how special information is presented in this document.



**Danger** — Danger indicates that the described activity or situation may result in serious personal injury or death; for example, high voltage or electric shock hazards.



**Warning** — Warning indicates that the described activity or situation may, or will, cause equipment damage or serious performance problems.



**Caution** — Caution indicates that the described activity or situation may, or will, cause service interruption.



**Note** — A note provides information that is, or may be, of special interest.

---

## 1.9.1 Procedures with options or substeps

When there are options in a procedure, they are identified by letters. When there are required substeps in a procedure, they are identified by roman numerals.

### Procedure 3 Example of options in a procedure

At step 1, you can choose option a or b. At step 2, you must do what the step indicates.

- 
- 1 This step offers two options. You must choose one of the following:
    - a This is one option.
    - b This is another option.
- 

- 2 You must perform this step.
- 

### Procedure 4 Example of required substeps in a procedure

At step 1, you must perform a series of substeps within a step. At step 2, you must do what the step indicates.

- 
- 1 This step has a series of substeps that you must perform to complete the step. You must perform the following substeps:
    - i This is the first substep.
    - ii This is the second substep.
    - iii This is the third substep.
- 

- 2 You must perform this step.
-

---

## 1.10 Multiple PDF document search

You can use Adobe Reader Release 6.0 and later to search multiple PDF files for a common term. Adobe Reader displays the results in a single display panel. The results are grouped by PDF file, and you can expand the entry for each file.



**Note** — The PDF files in which you search must be in the same folder.

### Procedure 5 To search multiple PDF files for a common term

- 
- 1 Open Adobe Acrobat Reader.

---

  - 2 Choose Edit→Search from the Acrobat Reader main menu. The Search PDF panel appears.

---

  - 3 Enter the search criteria.

---

  - 4 Click on the All PDF Documents In radio button.

---

  - 5 Select the folder in which to search using the drop-down menu.

---

  - 6 Click on the Search button.

Acrobat Reader displays the search results. You can expand the entries for each document by clicking on the + symbol.

---





# Table of contents

<b>1</b>	<b>Preface</b> .....	<b>3</b>
1.1	Scope .....	3
1.2	Audience.....	3
1.3	Required knowledge.....	3
1.4	Acronyms and initialisms .....	3
1.5	Assistance and ordering phone numbers .....	3
1.6	Nokia quality processes.....	4
1.7	Safety information.....	4
1.8	Documents .....	4
1.9	Special information .....	5
1.9.1	Procedures with options or substeps.....	6
1.10	Multiple PDF document search .....	7
<b>2</b>	<b>ETSI ONT safety guidelines</b> .....	<b>17</b>
2.1	Safety instructions .....	17
2.1.1	Safety instruction boxes .....	17
2.1.2	Safety-related labels.....	18
2.2	Safety standards compliance .....	19
2.2.1	EMC, EMI, and ESD compliance.....	19
2.2.2	Equipment safety standard compliance.....	19
2.2.3	Environmental standard compliance .....	19
2.2.4	Laser product standard compliance .....	20
2.2.5	Resistibility requirements compliance .....	20
2.2.6	Acoustic noise emission standard compliance .....	20
2.3	Electrical safety guidelines .....	20
2.3.1	Power supplies .....	20
2.3.2	Cabling .....	21
2.3.3	Protective earth .....	21
2.4	ESD safety guidelines .....	21
2.5	Laser safety guidelines.....	21
2.5.1	Laser classification .....	22
2.5.1.1	Laser warning labels.....	22
2.5.2	Transmit optical output .....	24
2.5.3	Normal laser operation .....	24
2.5.4	Location class.....	25
2.6	Environmental requirements.....	25
<b>3</b>	<b>ETSI environmental and CRoHS guidelines</b> .....	<b>27</b>
3.1	Environmental labels .....	27
3.1.1	Overview.....	27
3.1.2	Environmental related labels .....	27
3.1.2.1	Products below Maximum Concentration Value (MCV) label.....	27
3.1.2.2	Products containing hazardous substances above Maximum Concentration Value (MCV) label .....	28
3.2	Hazardous Substances Table (HST).....	29
3.3	Other environmental requirements .....	29

3.3.1	ONT environmental requirements .....	29
3.3.2	Storage .....	29
3.3.3	Transportation .....	30
3.3.4	Stationary use.....	30
3.3.5	Thermal limitations .....	30
3.3.6	Material content compliance.....	30
3.3.7	End-of-life collection and treatment.....	31
<b>4</b>	<b>ANSI ONT safety guidelines .....</b>	<b>33</b>
4.1	Safety instructions .....	33
4.1.1	Safety instruction boxes in customer documentation .....	33
4.1.2	Safety-related labels.....	34
4.2	Safety standards compliance .....	35
4.2.1	EMC, EMI, and ESD standards compliance.....	36
4.2.2	Equipment safety standard compliance.....	36
4.2.3	Environmental standards compliance.....	37
4.2.4	Laser product standards compliance.....	37
4.2.5	Resistibility requirements compliance .....	38
4.3	Laser safety guidelines.....	38
4.3.1	Laser warning labels.....	38
4.3.2	Laser classification .....	40
4.3.3	Transmit optical output .....	41
4.3.4	Normal laser operation .....	41
4.3.5	Location class.....	41
4.4	Electrical safety guidelines .....	42
4.4.1	Power supplies .....	42
4.4.2	Cabling .....	42
4.4.3	Protective earth .....	42
4.5	ESD safety guidelines .....	42
4.6	Environmental requirements.....	43
<b>5</b>	<b>G-2425G-A unit data sheet.....</b>	<b>45</b>
5.1	G-2425G-A part numbers and identification .....	45
5.2	G-2425G-A general description.....	47
5.2.1	TR-069 parameter support .....	50
5.2.1.1	Host object support.....	50
5.2.1.2	Port forwarding support .....	50
5.2.1.3	Optical parameters support .....	50
5.2.1.4	Object support for WiFi parameters.....	51
5.2.1.5	Statistics and troubleshooting support.....	51
5.2.1.6	Diagnostic parameter support .....	51
5.2.2	Independent TR69 session with Saas .....	52
5.2.3	TR69 authentication using TLS and CA certificates .....	53
5.2.4	TR-104 parameter extension support for voice service.....	53
5.2.5	TR-104 voice-related alarms .....	53
5.2.6	TR-104 parameters for FX line testing .....	53
5.2.7	TR-111 support.....	54
5.3	G-2425G-A software and installation feature support .....	54
5.4	G-2425G-A interfaces and interface capacity.....	54
5.4.1	G-2425G-A connections and components .....	55

5.5	G-2425G-A LEDs .....	57
5.6	G-2425G-A detailed specifications .....	59
5.7	G-2425G-A GEM ports and T-CONTs.....	60
5.8	G-2425G-A performance monitoring statistics .....	60
5.9	G-2425G-A functional blocks.....	62
5.10	G-2425G-A standards compliance .....	63
5.10.1	Energy-related products standby and off modes compliance.....	64
5.10.2	FCC statement .....	64
5.10.3	FCC Radiation Exposure Statement .....	65
5.11	G-2425G-A special considerations.....	65
5.11.1	Wi-Fi service.....	65
5.11.1.1	Wi-Fi physical features .....	65
5.11.1.2	Wi-Fi standards and certifications .....	66
5.11.1.3	Wi-Fi GUI features.....	66
5.11.2	G-2425G-A ONT considerations and limitations .....	66
<b>6</b>	<b>Install a G-2425G-A indoor ONT .....</b>	<b>67</b>
6.1	Purpose .....	67
6.2	General.....	67
6.3	Prerequisites.....	67
6.4	Recommended tools.....	67
6.5	Safety information.....	68
6.6	Procedure .....	69
<b>7</b>	<b>Replace a G-2425G-A indoor ONT .....</b>	<b>71</b>
7.1	Purpose .....	71
7.2	General.....	71
7.3	Prerequisites.....	71
7.4	Recommended tools.....	71
7.5	Safety information.....	72
7.6	Procedure .....	73
<b>8</b>	<b>Configure a G-2425G-A indoor ONT .....</b>	<b>77</b>
8.1	General.....	77
8.2	HGU mode GUI configuration.....	77
8.2.1	Login.....	77
8.2.2	Device and connection status.....	78
8.2.3	Network configuration.....	91
8.2.4	Security configuration .....	112
8.2.5	Application configuration .....	124
8.2.6	Maintenance .....	132
8.2.7	RG troubleshooting counters.....	145
<b>9</b>	<b>ONT configuration file over OMCI .....</b>	<b>149</b>
9.1	Purpose .....	149
9.2	Supported configuration file types .....	149
9.2.1	Filename conventions.....	151
9.3	ONT configuration file over OMCI .....	151



# List of figures

<b>1</b>	<b>Preface</b> .....	<b>3</b>
<b>2</b>	<b>ETSI ONT safety guidelines</b> .....	<b>17</b>
Figure 1	PSE certification .....	19
Figure 2	Laser product label .....	22
Figure 3	Laser classification label.....	23
Figure 4	Laser warning labels.....	24
<b>3</b>	<b>ETSI environmental and CRoHS guidelines</b> .....	<b>27</b>
Figure 5	Products below MCV value label.....	28
Figure 6	Products above MCV value label .....	28
Figure 7	Recycling/take back/disposal of product symbol .....	31
<b>4</b>	<b>ANSI ONT safety guidelines</b> .....	<b>33</b>
Figure 8	Sample safety label on the ONT equipment.....	35
Figure 9	Sample laser product label showing CDRH 21 CFR compliance .....	37
Figure 10	Laser product label .....	39
Figure 11	Laser classification label.....	39
Figure 12	Laser warning labels.....	40
Figure 13	Sample laser product safety label on the ONT equipment.....	41
<b>5</b>	<b>G-2425G-A unit data sheet</b> .....	<b>45</b>
Figure 14	G-2425G-A ONT.....	48
Figure 15	G-2425G-A indoor ONT physical connections (back) .....	55
Figure 16	G-2425G-A indoor ONT with fiber optic connector.....	56
Figure 17	G-2425G-A indoor ONT LEDs.....	57
Figure 18	G-2425G-A ONT functional block.....	63
<b>6</b>	<b>Install a G-2425G-A indoor ONT</b> .....	<b>67</b>
Figure 19	G-2425G-A ONT connections .....	69
<b>7</b>	<b>Replace a G-2425G-A indoor ONT</b> .....	<b>71</b>
Figure 20	G-2425G-A indoor ONT connections .....	74
<b>8</b>	<b>Configure a G-2425G-A indoor ONT</b> .....	<b>77</b>
Figure 21	Web login window.....	78
Figure 22	Device Information window.....	79
Figure 23	LAN status window .....	81
Figure 24	WAN status window.....	83
Figure 25	WAN status IPv6 window .....	85
Figure 26	Home networking information window .....	87
Figure 27	Optics module status window .....	88
Figure 28	Voice Information window.....	90
Figure 29	LAN network window .....	92
Figure 30	LAN IPv6 network window.....	94
Figure 31	WAN network window.....	96
Figure 32	WAN DHCP window .....	97
Figure 33	WiFi 2.4GHz network window.....	99
Figure 34	WiFi 5GHz network window.....	102

---

Figure 35	Wireless Schedule window.....	104
Figure 36	IP Routing network window.....	105
Figure 37	DNS network window.....	107
Figure 38	TR-069 network window.....	108
Figure 39	QoS Config window (L2).....	110
Figure 40	QoS Config window (L3).....	111
Figure 41	Firewall window.....	113
Figure 42	MAC filter window.....	114
Figure 43	IP filter window.....	116
Figure 44	URL Filter window.....	117
Figure 45	Parental Control window.....	120
Figure 46	DMZ and ALG window.....	122
Figure 47	Access Control window.....	123
Figure 48	Port forwarding window.....	125
Figure 49	Port Triggering window.....	126
Figure 50	DDNS window.....	128
Figure 51	NTP window.....	129
Figure 52	USB window.....	130
Figure 53	UPnP and DLNA window.....	132
Figure 54	Password window.....	134
Figure 55	Speed Test window.....	135
Figure 56	LOID Config window.....	136
Figure 57	SLID configuration window.....	137
Figure 58	Device management window.....	138
Figure 59	Backup and Restore window.....	139
Figure 60	Firmware upgrade window.....	140
Figure 61	Reboot window.....	141
Figure 62	Factory default window.....	142
Figure 63	Diagnostics window.....	143
Figure 64	Log window.....	144
Figure 65	RG Troubleshooting Counters window.....	146
<b>9</b>	<b>ONT configuration file over OMCI.....</b>	<b>149</b>

# List of tables

<b>1</b>	<b>Preface</b> .....	<b>3</b>
<b>2</b>	<b>ETSI ONT safety guidelines</b> .....	<b>17</b>
Table 1	Safety labels .....	18
<b>3</b>	<b>ETSI environmental and CRoHS guidelines</b> .....	<b>27</b>
<b>4</b>	<b>ANSI ONT safety guidelines</b> .....	<b>33</b>
Table 2	Safety labels .....	34
<b>5</b>	<b>G-2425G-A unit data sheet</b> .....	<b>45</b>
Table 3	Identification of G-2425G-A indoor ONTs.....	45
Table 4	G-2425G-A power supply ordering information .....	46
Table 5	G-2425G-A indoor ONT interface connection capacity .....	54
Table 6	G-2425G-A indoor ONT physical connections .....	56
Table 7	G-2425G-A indoor ONT LED descriptions .....	58
Table 8	G-2425G-A indoor ONT physical specifications .....	59
Table 9	G-2425G-A indoor ONT power consumption specifications .....	59
Table 10	G-2425G-A indoor ONT environmental specifications .....	60
Table 11	G-2425G-A indoor ONT capacity for GEM ports and T-CONTs.....	60
Table 12	Package S ONTs ONTENET performance monitoring statistics .....	61
Table 13	Package S ONTs ONTL2UNI performance monitoring statistics .....	61
Table 14	Package S ONTs PONONTTC, PONONTMCTC, PONONTTCHSI, PONONTTCES, PONONTTCFLOW, PONONTTCVOIP performance monitoring statistics .....	62
Table 15	Package S ONTs PONONTTC aggregate performance monitoring statistics 62	
Table 16	G-2425G-A ONT considerations and limitations .....	66
<b>6</b>	<b>Install a G-2425G-A indoor ONT</b> .....	<b>67</b>
<b>7</b>	<b>Replace a G-2425G-A indoor ONT</b> .....	<b>71</b>
<b>8</b>	<b>Configure a G-2425G-A indoor ONT</b> .....	<b>77</b>
Table 17	Device Information parameters .....	79
Table 18	LAN status parameters.....	81
Table 19	WAN status parameters .....	83
Table 20	WAN status IPv6 parameters .....	85
Table 21	Home networking parameters .....	87
Table 22	Optics module status parameters.....	89
Table 23	Voice Information parameters .....	90
Table 24	LAN network parameters.....	93
Table 25	LAN IPv6 network parameters.....	94
Table 26	WAN network parameters .....	96
Table 27	WAN DHCP parameters.....	98
Table 28	WiFi 2.4GHz network parameters .....	100
Table 29	WiFi 5GHz network parameters .....	102
Table 30	IP Routing network parameters .....	105
Table 31	DNS network parameters .....	107

---

Table 32	TR-069 network parameters.....	108
Table 33	QoS Config parameters.....	111
Table 34	Firewall parameters.....	113
Table 35	MAC filter parameters.....	115
Table 36	IP filter parameters.....	116
Table 37	URL Filter parameters.....	117
Table 38	Parental control parameters.....	121
Table 39	DMZ and ALG parameters.....	122
Table 40	Access control parameters.....	124
Table 41	Port forwarding parameters.....	125
Table 42	Port triggering parameters.....	127
Table 43	DDNS parameters.....	128
Table 44	NTP parameters.....	129
Table 45	USB parameters.....	131
Table 46	Password parameters.....	134
Table 47	LOID configuration parameters.....	136
Table 48	SLID configuration parameters.....	137
Table 49	Device management parameters.....	138
Table 50	RG Troubleshooting Counters parameters.....	146
<b>9</b>	<b>ONT configuration file over OMCI.....</b>	<b>149</b>
Table 51	Supported configuration files.....	150



---

## 2 ETSI ONT safety guidelines

This chapter provides information about the mandatory regulations that govern the installation and operation of the optical network terminals (ONTs).

### 2.1 Safety instructions

This section describes the safety instructions that are provided in the ONT customer documentation and on the equipment.

#### 2.1.1 Safety instruction boxes

The safety instruction boxes are provided in the ONT customer documentation. Observe the instructions to meet safety requirements.

The following is an example of the Danger box.



**Danger** — Possibility of personal injury.

The Danger box indicates that the described activity or situation may pose a threat to personal safety. It calls attention to a situation or procedure which, if not correctly performed or adhered to, may result in death or serious physical harm.

Do not proceed beyond a Danger box until the indicated conditions are fully understood and met.

The following is an example of the Warning box.



**Warning 1** — Possibility of equipment damage.

**Warning 2** — Possibility of data loss.

The Warning box indicates that the described activity or situation may, or will, cause equipment damage, loss of data, or serious performance problems. It identifies a possible equipment-damaging situation or provides essential information to avoid the degradation of system operations or data.

Do not proceed beyond a warning until the indicated conditions are fully understood and met.

The following is an example of the Caution box.



**Caution 1** — Possibility of service interruption.

**Caution 2** — Service interruption.

The Caution box indicates that the described activity or situation may, or will, cause service interruption.

Do not proceed beyond a caution until the indicated conditions are fully understood and met.

The following is an example of the Note box.



**Note** — Information of special interest.

The Note box provides information that assists the personnel working with ONTs. It does not provide safety-related instructions.

## 2.1.2 Safety-related labels

The ONT equipment is labeled with the specific safety instructions and compliance information that is related to a variant of the ONT. Observe the instructions on the safety labels.

Table 1 provides sample safety labels on the ONT equipment.

**Table 1** Safety labels

Description	Label text
ESD warning	Caution: This assembly contains an electrostatic sensitive device.
Laser classification	Class 1 laser product
PSE marking	These power supplies are Japan PSE certified and compliant with Japan VCCI emissions standards.

Figure 1 shows the PSE certification.

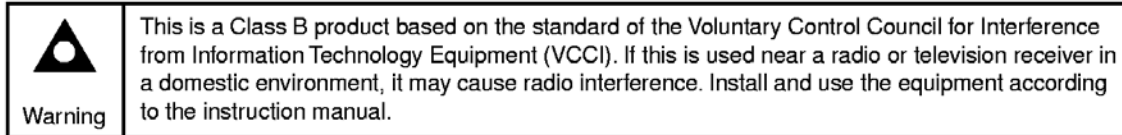
**Figure 1 PSE certification**

19841

## 2.2 Safety standards compliance

This section describes the ONT compliance with the European safety standards.

### 2.2.1 EMC, EMI, and ESD compliance

The ONT equipment complies with the following EMC, EMI, and ESD requirements:

- EN 300-328 v1.9.1 wide band data transmission standards for 2.4GHz bands
- EN 300-386 V1.5.1: Electromagnetic Compatibility and Radio Spectrum Matters (ERM): Telecommunications Network Equipment; Electromagnetic Compatibility (EMC) requirements; Electrostatic Discharge (ESD) requirements
- EN 55022 (2006): Class B, Information Technology Equipment, Radio Disturbance Characteristics, limits and methods of measurement
- EN 55024 (2010): Information Technology Equipment, Immunity Characteristics, limits and methods of measurement
- European Council Directive 2004/108/EC
- EN 300-386 V1.4.1: 2008
- EN 55022:2006 Class B (ONTs)

### 2.2.2 Equipment safety standard compliance

The ONT equipment complies with the requirements of EN 60950-1, Safety of Information Technology Equipment for use in a restricted location (per R-269).

### 2.2.3 Environmental standard compliance

The ONT equipment complies with the EN 300 019 European environmental standards.

---

## 2.2.4 Laser product standard compliance

For most ONTs, the ONT equipment complies with EN 60825-1 and IEC 60825-2 for laser products. If there is an exception to this compliance regulation, you can find this information in the standards compliance section of the unit data sheet in this Product Guide.

## 2.2.5 Resistibility requirements compliance

The ONT equipment complies with the requirements of ITU Recommendation K.21 for resistibility of telecommunication equipment installed in customer premises to over voltage and overcurrents.

## 2.2.6 Acoustic noise emission standard compliance

The ONT equipment complies with EN 300 753 acoustic noise emission limit and test methods.

## 2.3 Electrical safety guidelines

This section provides the electrical safety guidelines for the ONT equipment.



**Note 1** — The ONTs comply with the U.S. National Electrical Code. However, local electrical authorities have jurisdiction when there are differences between the local and U.S. standards.

**Note 2** — The ONTs comply with BS EN 61140.

### 2.3.1 Power supplies

The use of any non-Nokia approved power supplies or power adapters is not supported or endorsed by Nokia. Such use will void any warranty or support contract with Nokia. Such use greatly increases the danger of damage to equipment or property.

---

## 2.3.2 Cabling

The following are the guidelines regarding cables used for the ONT equipment:

- All cables must be approved by the relevant national electrical code.
- The cables for outdoor installation of ONTs must be suitable for outdoor use.
- POTS wiring run outside the subscriber premises must comply with the requirements of local electrical codes. In some markets, the maximum allowed length of the outside run is 140 feet (43 m). If the outside run is longer, NEC requires primary protection at both the exit and entry points for the wire.

## 2.3.3 Protective earth

Earthing and bonding of the ONTs must comply with the requirements of local electrical codes.

## 2.4 ESD safety guidelines

The ONT equipment is sensitive to ESD. Operations personnel must observe the following ESD instructions when they handle the ONT equipment.



**Caution** — This equipment is ESD sensitive. Proper ESD protections should be used when you enter the TELCO Access portion of the ONT.

During installation and maintenance, service personnel must wear wrist straps to prevent damage caused by ESD.

## 2.5 Laser safety guidelines

Observe the following instructions when you perform installation, operations, and maintenance tasks on the ONT equipment.

Only qualified service personnel who are extremely familiar with laser radiation hazards should install or remove the fiber optic cables and units in this system.



**Danger** — There may be invisible laser radiation at the fiber optic cable when the cable is removed from the connector. Avoid direct exposure to the laser beam.

Observe the following danger for laser hazard. Eyes can be damaged when they are exposed to a laser beam. Take necessary precautions before you plug in the optical modules.



**Danger** — Possibility of equipment damage. Risk of eye damage by laser radiation.

## 2.5.1 Laser classification

The ONT is classified as a Class 1 laser product based on its transmit optical output.

### 2.5.1.1 Laser warning labels

The following figures show the labels related to laser product, classification and warning.

Figure 2 shows a laser product label.

**Figure 2** Laser product label

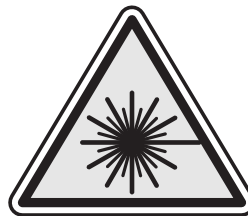

18455

Figure 3 shows a laser classification label. Laser classification labels may be provided in other languages.

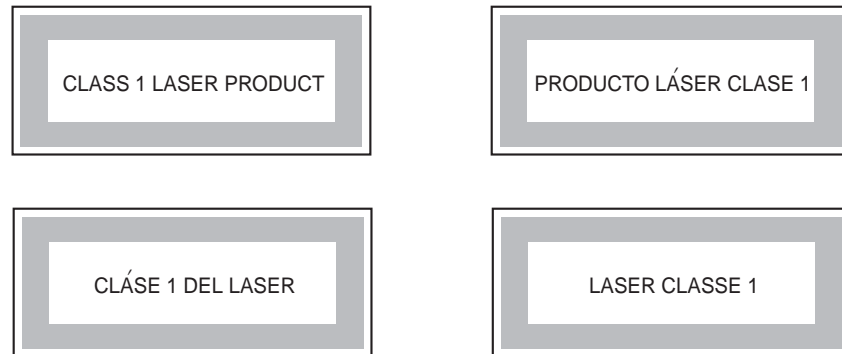
**Figure 3 Laser classification label**

18992

Figure 4 shows a laser warning label and an explanatory label for laser products. Labels and warning may be provided in other languages. The explanatory label provides the following information:

- a warning that calls attention to the invisible laser radiation
- an instruction against staring into the beam or viewing directly with optical instruments
- wavelength
- normal output power
- maximum output power

**Figure 4 Laser warning labels**

18993

## 2.5.2 Transmit optical output

The maximum transmit optical output of an ONT is +5 dBm.

## 2.5.3 Normal laser operation

In normal operation, fiber cable laser radiation is always off until it receives signal from the line terminal card.

Eyes can be damaged when they exposed to a laser beam. Operating personnel must observe the instructions on the laser explanatory label before plugging in the optical module.



**Danger** — Risk of eye damage by laser radiation.



## 2.5.4 Location class

Use cable supports and guides to protect the receptacles from strain.

## 2.6 Environmental requirements

See the ONT technical specification documentation for more information about temperature ranges.

During operation in the supported temperature range, condensation inside the ONT caused by humidity is not an issue. To avoid condensation caused by rapid changes in temperature and humidity, Nokia recommends:

- The door of the ONT not be opened until temperature inside and outside the enclosure has stabilized.
- If the door of the ONT must be opened after a rapid change in temperature or humidity, use a dry cloth to wipe down the metal interior to prevent the risk of condensation.
- When high humidity is present, installation of a cover or tent over the ONT helps prevent condensation when the door is opened.



---

## 3 ETSI environmental and CRoHS guidelines

This chapter provides information about the ETSI environmental China Restriction of Hazardous Substances (CRoHS) regulations that govern the installation and operation of the optical line termination (OLT) and optical network termination (ONT) systems. This chapter also includes environmental operation parameters of general interest.

### 3.1 Environmental labels

This section describes the environmental instructions that are provided with the customer documentation, equipment, and location where the equipment resides.

#### 3.1.1 Overview

CRoHS is applicable to Electronic Information Products (EIP) manufactured or sold and imported in the territory of the mainland of the People's Republic of China. EIP refers to products and their accessories manufactured by using electronic information technology, including electronic communications products and such subcomponents as batteries and cables.

#### 3.1.2 Environmental related labels

Environmental labels are located on appropriate equipment. The following are sample labels.

##### 3.1.2.1 Products below Maximum Concentration Value (MCV) label

Figure 5 shows the label that indicates a product is below the maximum concentration value, as defined by standard SJ/T11363-2006 (Requirements for Concentration Limits for Certain Hazardous Substances in Electronic Information Products). Products with this label are recyclable. The label may be found in this documentation or on the product.

**Figure 5** Products below MCV value label



18986

### 3.1.2.2 Products containing hazardous substances above Maximum Concentration Value (MCV) label

Figure 6 shows the label that indicates a product is above the maximum concentration value, as defined by standard SJ/T11363-2006 (Requirements for Concentration Limits for Certain Hazardous Substances in Electronic Information Products). The number contained inside the label indicates the Environment-Friendly User Period (EFUP) value. The label may be found in this documentation or on the product.

**Figure 6** Products above MCV value label



Together with major international telecommunications equipment companies, Nokia has determined it is appropriate to use an EFUP of 50 years for network infrastructure equipment and an EFUP of 20 years for handsets and accessories. These values are based on manufacturers' extensive practical experience of the design, manufacturing, maintenance, usage conditions, operating environments, and physical condition of infrastructure and handsets after years of service. The values reflect minimum values and refer to products operated according to the intended use conditions. See "[Hazardous Substances Table \(HST\)](#)" for more information.

## 3.2 Hazardous Substances Table (HST)

This section describes the compliance of the OLT and ONT equipment to the CRoHS standard when the product and subassemblies contain hazardous substances beyond the MCV value. This information is found in this user documentation where part numbers for the product and subassemblies are listed. It may be referenced in other OLT and ONT documentation.

In accordance with the People's Republic of China Electronic Industry Standard Marking for the Control of Pollution Caused by Electronic Information Products (SJ/T11364-2006), customers may access the Nokia Hazardous Substance Table, in Chinese, from the following location:

- <http://www.alcatel-sbell.com.cn/wwwroot/images/upload/private/1/media/ChinaRoHS.pdf>

## 3.3 Other environmental requirements

Observe the following environmental requirements when handling the P-OLT or ONT equipment.

### 3.3.1 ONT environmental requirements

See the ONT technical specification documentation for more information about temperature ranges.

### 3.3.2 Storage

According to ETS 300-019-1-1 - Class 1.1, storage of OLT equipment must be in Class 1.1, weather-protected, temperature-controlled locations.

---

### 3.3.3 Transportation

According to EN 300-019-1-2 - Class 2.3, transportation of the OLT equipment must be in packed, public transportation with no rain on packing allowed.

### 3.3.4 Stationary use

According to EN 300-019-1-3 - Class 3.1/3.2/3.E, stationary use of OLT equipment must be in a temperature-controlled location, with no rain allowed, and with no condensation allowed.

### 3.3.5 Thermal limitations

When the OLT is installed in the CO or CEV, install air filters on the P-OLT. The thermal limitations for OLT operation in a CO or CEV are:

- operating temperature: 5°C to 40°C (41°F to 104°F)
- short-term temperature: -5°C to 50°C (23°F to 122°F)
- operating relative humidity: 5% to 85%
- short-term relative humidity: 5% to 95%, but not to exceed 0.024 kg of water/kg

### 3.3.6 Material content compliance

European Union (EU) Directive 2002/95/EC, "Restriction of the use of certain Hazardous Substances" (RoHS), restricts the use of lead, mercury, cadmium, hexavalent chromium, and certain flame retardants in electrical and electronic equipment. This Directive applies to electrical and electronic products placed on the EU market after 1 July 2006, with various exemptions, including an exemption for lead solder in network infrastructure equipment. Nokia products shipped to the EU after 1 July 2006 comply with the EU RoHS Directive.

Nokia has implemented a material/substance content management process. The process is described in: Nokia process for ensuring RoHS Compliance (1AA002660031ASZZA). This ensures compliance with the European Union Directive 2011/65/EU on the Restriction of the Use of Certain Hazardous Substances in Electrical and Electronic Equipment (RoHS2). With the process equipment is assessed in accordance with the Harmonised Standard EN50581:2012 (CENELEC) on Technical documentation for the assessment of electrical and electronic products with respect to the restriction of hazardous substances.

### 3.3.7 End-of-life collection and treatment

Electronic products bearing or referencing the symbol shown in Figure 7, when put on the market within the European Union (EU), shall be collected and treated at the end of their useful life, in compliance with applicable EU and local legislation. They shall not be disposed of as part of unsorted municipal waste. Due to materials that may be contained in the product, such as heavy metals or batteries, the environment and human health may be negatively impacted as a result of inappropriate disposal.



**Note** — In the European Union, a solid bar under the symbol for a crossed-out wheeled bin indicates that the product was put on the market after 13 August 2005.

**Figure 7** Recycling/take back/disposal of product symbol



At the end of their life, the OLT and ONT products are subject to the applicable local legislations that implement the European Directive 2012/19EU on waste electrical and electronic equipment (WEEE).

There can be different requirements for collection and treatment in different member states of the European Union.

In compliance with legal requirements and contractual agreements, where applicable, Nokia will offer to provide for the collection and treatment of Nokia products bearing the logo shown in Figure 7 at the end of their useful life, or products displaced by Nokia equipment offers. For information regarding take-back of equipment by Nokia, or for more information regarding the requirements for recycling/disposal of product, contact your Nokia account manager or Nokia take back support at [sustainability.global@nokia.com](mailto:sustainability.global@nokia.com).





---

## 4 ANSI ONT safety guidelines

This chapter provides information about the mandatory regulations that govern the installation and operation of the optical network terminals or units (ONTs or ONUs) in the North American or ANSI market.

### 4.1 Safety instructions

This section describes the safety instructions that are provided in the ONT customer documentation and on the equipment.

#### 4.1.1 Safety instruction boxes in customer documentation

The safety instruction boxes are provided in the ONT customer documentation. Observe the instructions to meet safety requirements.

The following is an example of the Danger box.



**Danger** — Possibility of personal injury.

The Danger box indicates that the described activity or situation may pose a threat to personal safety. It calls attention to a situation or procedure which, if not correctly performed or adhered to, may result in death or serious physical harm.

Do not proceed beyond a Danger box until the indicated conditions are fully understood and met.

The following is an example of the Warning box.



**Warning 1** — Possibility of equipment damage.

**Warning 2** — Possibility of data loss.

The Warning box indicates that the described activity or situation may, or will, cause equipment damage, loss of data, or serious performance problems. It identifies a possible equipment-damaging situation or provides essential information to avoid the degradation of system operations or data.

Do not proceed beyond a warning until the indicated conditions are fully understood and met.

The following is an example of the Caution box.



**Caution 1** — Possibility of service interruption.

**Caution 2** — Service interruption.

The Caution box indicates that the described activity or situation may, or will, cause service interruption.

Do not proceed beyond a caution until the indicated conditions are fully understood and met.

The following is an example of the Note box.



**Note** — Information of special interest.

The Note box provides information that assists the personnel working with ONTs. It does not provide safety-related instructions.

## 4.1.2 Safety-related labels

The ONT equipment is labeled with specific safety compliance information and instructions that are related to a variant of the ONT. Observe the instructions on the safety labels.

Table 2 provides examples of the text in the various ONT safety labels.

**Table 2** Safety labels

Description	Label text
UL compliance	Communication service equipment US listed. Type 3R enclosure - Rainproof.
TUV compliance	Type 3R enclosure - Rainproof.
ESD warning	Caution: This assembly contains electrostatic sensitive device.
Laser classification	Class 1 laser product
Laser product compliance	This laser product conforms to all applicable standards of 21 CFR 1040.10 at date of manufacture.
FCC standards compliance	Tested to comply with FCC standards for home or office use.
CDRH compliance	Complies with 21 CFR 1040.10 and 1040.11 except for deviations pursuant to Laser Notice No. 50, dated June 24, 2007

(1 of 2)

Description	Label text
Operation conditions	This device complies with Part 15 of the FCC Rules. Operation is subject to the following two conditions: (1) this device may not cause harmful interference, and (2) this device must accept any interference received, including interference that may cause undesired operation.
Canadian standard compliance (modular ONT)	This Class A digital apparatus complies with Canadian ICES-003.
Canadian standard compliance (outdoor ONT)	This Class B digital apparatus complies with Canadian ICES-003.
CE marking	There are various CE symbols for CE compliance.

(2 of 2)

Figure 8 shows a sample safety label on the ONT equipment.

**Figure 8 Sample safety label on the ONT equipment**

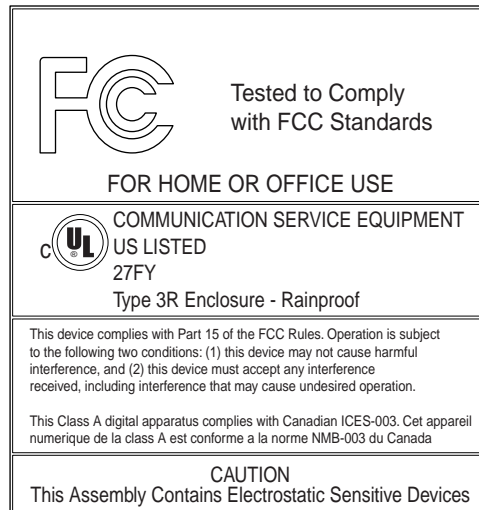

18533

## 4.2 Safety standards compliance

This section describes the ONT compliance with North American safety standards.



**Warning** — Changes or modifications to this unit not expressly approved by the party responsible for compliance could void the user's authority to operate the equipment.

---

## 4.2.1 EMC, EMI, and ESD standards compliance

The ONT equipment complies with the following requirements:

- Federal Communications Commission (FCC) CFR 47, Part 15, Subpart B, Class A requirements for OLT equipment
- GR-1089-CORE requirements, including:
  - Section 3 Electromagnetic Interference, Emissions Radiated and Conducted
  - Section 3 Immunity, Radiated and Conducted
  - Section 2 ESD Discharge Immunity: System Level Electrostatic Discharge and EFT Immunity: Electrically Fast Transients

This equipment has been tested and found to comply with the limits for a Class B digital device, pursuant to Part 15 of the FCC Rules. These limits are designed to provide reasonable protection against harmful interference in a residential installation. This equipment generates, uses and can radiate radio frequency energy and, if not installed and used in accordance with the instructions, may cause harmful interference to radio communications.

However, there is no guarantee that interference will not occur in a particular installation. If this equipment does cause harmful interference to radio or television reception, which can be determined by turning the equipment off and on, the user is encouraged to try to correct the interference by one or more of the following measures:

- Reorient or relocate the receiving antenna.
- Increase the separation between the equipment and receiver.
- Connect the equipment into an outlet on a circuit different from that to which the receiver is needed.
- Consult the dealer or an experienced radio/TV technician for help.

## 4.2.2 Equipment safety standard compliance

The ONT equipment complies with the requirements of UL60950-1, Outdoor ONTs to “Communication Service Equipment” (CSE) and Indoor ONTs to Information Technology Equipment (ITE).

### 4.2.3 Environmental standards compliance

The ONT equipment complies with the following standards:

- GR-63-CORE (NEBS): requirements related to operating, storage, humidity, altitude, earthquake, office vibration, transportation and handling, fire resistance and spread, airborne contaminants, illumination, and acoustic noise
- GR-487-CORE: requirements related to rain, chemical, sand, and dust
- GR-487 R3-82: requirements related to condensation
- GR-3108: Requirements for Network Equipment in the Outside Plant (OSP)
- TP76200: Common Systems Equipment Interconnections Standards

### 4.2.4 Laser product standards compliance

The ONT equipment complies with 21 CFR 1040.10 and CFR 1040.11, except for deviations pursuant to Laser Notice No. 50, dated June 24, 2007” or to 21 CFR 1040.10 U.S. Center for Devices and Radiological Health (CDRH) of the Food and Drug Administration (FDA) Laser Notice 42 for ONTs containing Class 1 Laser modules certified by original manufactures.

Per CDRH 21 CFR 10.40.10 (h) (1) (iv) distributors of Class 1 laser products, such as Nokia ONTs shall leave the following Laser Safety cautions with the end user.

- “Class 1 Laser Product”
- “Caution – Use of controls or adjustments or performance of procedures other than those specified herein may result in hazardous radiation exposure.”

Figure 9 shows a laser product label.

**Figure 9** Sample laser product label showing CDRH 21 CFR compliance

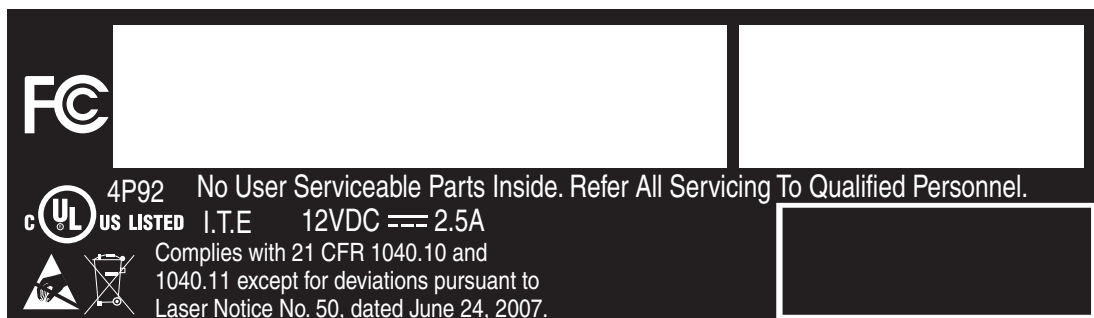

22813

## 4.2.5 Resistibility requirements compliance

The ONT equipment complies with the requirements of ITU Recommendation K.21 for resistibility of telecommunication equipment installed in customer premises to overvoltage and overcurrents.

## 4.3 Laser safety guidelines

Only qualified service personnel who are extremely familiar with laser radiation hazards should install or remove the fiber optic cables and units in this system.

Observe the following warnings when you perform installation, operations, and maintenance tasks on the ONT equipment.



**Danger** — There may be invisible laser radiation at the fiber optic cable when the cable is removed from the connector. Avoid direct exposure to beam.

Observe the following danger for a laser hazard. Eyes can be damaged when they are exposed to a laser beam. Take necessary precautions before you plug in the optical modules.



**Danger** — Possibility of equipment damage. Risk of eye damage by laser radiation.

Per CDRH 21 CFR 10.40.10 (h) (1) (iv) distributors of Class 1 laser products, such as Nokia ONTs shall leave the following Laser Safety cautions with the end user.

- a) "Class 1 Laser Product"
- b) "Caution – Use of controls or adjustments or performance of procedures other than those specified herein may result in hazardous radiation exposure."

### 4.3.1 Laser warning labels

The following figures show sample labels related to laser product, classification and warning.

Figure 10 shows a laser product label.

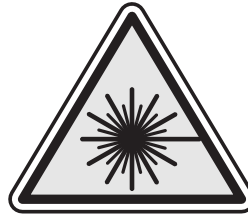
**Figure 10** Laser product label

18455

Figure 11 shows a laser classification label. Laser classification labels may be provided in other languages.

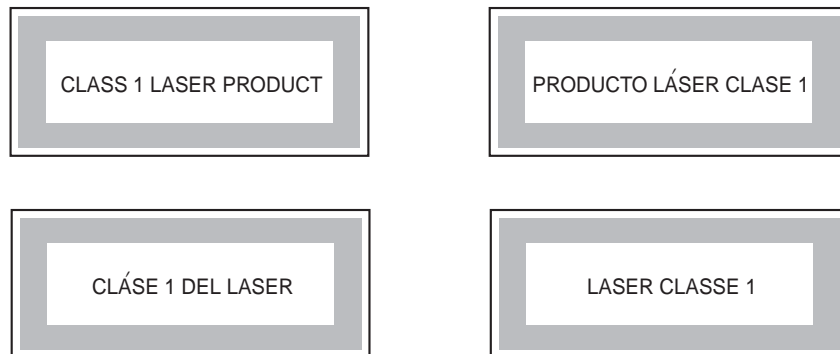
**Figure 11** Laser classification label

18992

Figure 12 shows a laser warning label and an explanatory label for laser products. Explanatory labels may be provided in other languages. The explanatory label provides the following information:

- a warning that calls attention to the invisible laser radiation
- an instruction against staring into the beam or viewing directly with optical instruments
- wavelength
- normal output power
- maximum output power

**Figure 12** Laser warning labels

18993

### 4.3.2 Laser classification

The ONT is classified as a Class 1 laser product based on its transmit optical output.

For Class 1 laser products, lasers are safe under reasonably foreseeable conditions of operation, including the use of optical instruments for intrabeam viewing.

Figure 13 shows a sample laser product safety label on the ONT equipment.



**Figure 13 Sample laser product safety label on the ONT equipment**

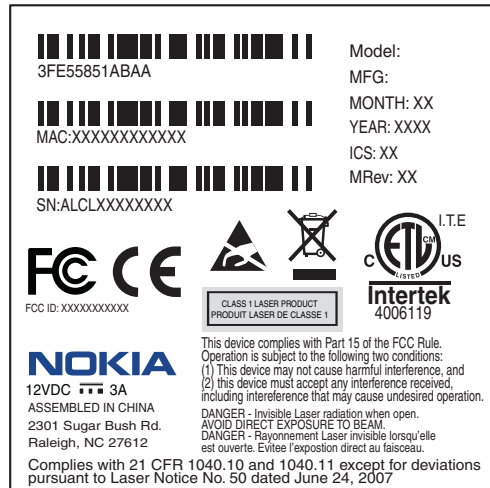

18532

### 4.3.3 Transmit optical output

The maximum transmit optical output of an ONT is +5 dBm.

### 4.3.4 Normal laser operation

In normal operation, fiber cable laser radiation is always off until it receives signal from the line terminal card.

Operating personnel must observe the instructions on the laser explanatory label before plugging in the optical module.



**Danger** — Risk of eye damage by laser radiation.

### 4.3.5 Location class

Use cable supports and guides to protect the receptacles from strain.

---

## 4.4 Electrical safety guidelines

This section provides the electrical safety guidelines for the ONT equipment.



**Note** — The ONTs comply with the U.S. National Electrical Code. However, local electrical authorities have jurisdiction when there are differences between the local and U.S. standards.

### 4.4.1 Power supplies

The use of any non-Nokia approved power supplies or power adapters is not supported or endorsed by Nokia. Such use will void any warranty or support contract with Nokia. Such use greatly increases the danger of damage to equipment or property.

### 4.4.2 Cabling

The following are the guidelines regarding cables used for the ONT equipment:

- Use only cables approved by the relevant national electrical code.
- Use cables suitable for outdoor use for outdoor installation of ONTs.
- The ONTs have been evaluated for use with external POTS wiring without primary protection that may not exceed 140 ft (43 m) in reach. However, the power cable must not exceed 100 ft (31 m).

### 4.4.3 Protective earth

Earthing and bonding of the ONTs must comply with the requirements of NEC article 250 or local electrical codes.

## 4.5 ESD safety guidelines

The ONT equipment is sensitive to ESD. Operations personnel must observe the following ESD instructions when they handle the ONT equipment.



**Caution** — This equipment is ESD sensitive. Proper ESD protections should be used when entering the TELCO Access portion of the ONT.

During installation and maintenance, service personnel must wear wrist straps to prevent damage caused by ESD.

Nokia recommends that you prepare the site before you install the ONT equipment. In addition, you must control relative humidity, use static dissipating material for furniture or flooring, and restrict the use of air conditioning.

## 4.6 Environmental requirements

See the ONT technical specification documentation for temperature ranges for ONTs.

During operation in the supported temperature range, condensation inside the ONT caused by humidity is not an issue. To avoid condensation caused by rapid changes in temperature and humidity, Nokia recommends:

- The door of the ONT not be opened until temperature inside and outside the enclosure has stabilized.
- If the door of the ONT must be opened after a rapid change in temperature or humidity, use a dry cloth to wipe down the metal interior to prevent the risk of condensation.
- When high humidity is present, installation of a cover or tent over the ONT helps prevent condensation when the door is opened.



## 5 G-2425G-A unit data sheet

- [5.1 G-2425G-A part numbers and identification](#)
- [5.2 G-2425G-A general description](#)
- [5.3 G-2425G-A software and installation feature support](#)
- [5.4 G-2425G-A interfaces and interface capacity](#)
- [5.5 G-2425G-A LEDs](#)
- [5.6 G-2425G-A detailed specifications](#)
- [5.7 G-2425G-A GEM ports and T-CONTs](#)
- [5.8 G-2425G-A performance monitoring statistics](#)
- [5.9 G-2425G-A functional blocks](#)
- [5.10 G-2425G-A standards compliance](#)
- [5.11 G-2425G-A special considerations](#)

### 5.1 G-2425G-A part numbers and identification

Table 3 provides part numbers and identification information for the G-2425G-A indoor ONT.

**Table 3** Identification of G-2425G-A indoor ONTs

Ordering kit part number	Provisioning number	Description	CLEI Code	CPR	ECI/ Bar code
3FE 48292 AA	3FE 48299 AB	G-2426G-A, GPON Dual Band 2+2 RGW ONT with EN7528, MTK7592, and MTC7613b processors. Supports 2 POTS ports, 4xGE, 2x2 802.11b/g/n 2.4G and 802.11ac 5G WLAN. Includes two USB 2.0 Type A ports and a 12V 2A wall-mounted AC/DC power adapter with 2-pin US input plug and a 1.5 m DC cable. External antenna with 5dBi gain for each.	—	—	—

(1 of 2)

Ordering kit part number	Provisioning number	Description	CLEI Code	CPR	ECI/ Bar code
3FE 48292 BA	3FA 48299 BA	G-2426G-A, GPON Dual Band 2+2 RGW ONT with EN7528, MTK7592, and MTC7613b processors. Supports 2 POTS ports, 4xGE, 2x2 802.11b/g/n 2.4G and 802.11ac 5G WLAN. Includes two USB 2.0 Type A ports and a 12V 2A wall-mounted AC/DC power adapter with 2-pin EU input plug and a 1.5 m DC cable. External antenna with 5dBi gain for each.	—	—	—
3FE 48292 BB	3FE 48299 BB	G-2426G-A, GPON Dual Band 2+2 RGW ONT with EN7528, MTK7592, and MTC7613b processors. Supports 2 POTS ports, 4xGE, 2x2 802.11b/g/n 2.4G and 802.11ac 5G WLAN. Includes two USB 2.0 Type A ports and a 12V 2A wall-mounted AC/DC power adapter with 2-pin EU input plug and a 1.5 m DC cable. External antenna with 5dBi gain for each.	—	—	—
3FE 48292 CA	3FE 48299 BA	G-2426G-A, GPON Dual Band 2+2 RGW ONT with EN7528, MTK7592, and MTC7613b processors. Supports 2 POTS ports, 4xGE, 2x2 802.11b/g/n 2.4G and 802.11ac 5G WLAN. Includes two USB 2.0 Type A ports and a 12V 2A wall-mounted AC/DC power adapter with 3-pin UK input plug and a 1.5 m DC cable. External antenna with 5dBi gain for each.	—	—	—
3FE 48292 AB	3FE 48299 AB	G-2426G-A, GPON Dual Band 2+2 RGW ONT with EN7528, MTK7592, and MTC7613b processors. Supports 2 POTS ports, 4xGE, 2x2 802.11b/g/n 2.4G and 802.11ac 5G WLAN. Includes two USB 2.0 Type A ports and a 12V 2A wall-mounted AC/DC power adapter with 2-pin US input plug and a 1.5 m DC cable. External antenna with 5dBi gain for each.	—	—	—

(2 of 2)

Table 4 provides the power supply information for the G-2425G-A ONT. For more information on power supplies, see the *7368 ISAM ONT Power Supply and UPS Guide*. The power consumption is less than 24 W.

**Table 4 G-2425G-A power supply ordering information**

ONT part numbers	Power model (Model No./Manufacture Part Number)	Power information	Customer category or country compliance tested for	Notes
Kit: 3FE 48292 AA EMA: 3FE 48299 AA	FUHUA: UES24WU-120200SPA/UE191025GWZ F2RI RUIDE: RD1202000-C55-154MG/BR120200-UC 6C-LL01	12 V, 2A wall mounted AC/DC power adapter, US plug in	ANSI municipality US, UL/CB certified, Mexico NOM certified	2-pin US input plug

(1 of 2)

ONT part numbers	Power model (Model No./Manufacture Part Number)	Power information	Customer category or country compliance tested for	Notes
Kit: 3FE 48292 BA EMA: 3FE 48299 BA	FUHUA: UES24WV-120200SPA/UE191025GWZ F1RI RUIDE: RD1202000-C55-154OG/BR120200-EC 6C-LL01	12 V, 2A wall mounted AC/DC power adapter, EU plug in	Europe, CE certified	2-pin EU input plug
Kit: 3FE 48292 BB EMA: 3FE48299 BB	FUHUA: UES24WV-120200SPA/UE191025GW ZF1RI RUIDE: RD1202000-C55-154OG/BR120200-EC 6C-LL01	12 V, 2A wall mounted AC/DC power adapter, EU plug in	Europe, CE certified	2-pin EU input plug
Kit: 3FE 48292 CA EMA: 3FE 48299 BA	FUHUA: UES24WB-120200SPA/UE191025GWZ F3RI RUIDE: RD1202000-C55-154YG/BR120200-Y C6C-LL01	12 V, 2A wall mounted AC/DC power adapter, UK plug in	UK, CE certified	Dummy 3-pin UK input plug
Kit: 3FE 48292 AA EMA: 3FE 48299 AA	FUHUA: UES24WU-120200SPA/UE191025GWZ F2RI RUIDE: RD1202000-C55-154MG/BR120200-UC 6C-LL01	12V, 2A wall mounted AC/DC power adapter, US plug.	ANSI municipality US, UL/CB certified, Mexico NOM certified	2-pin US input plug

(2 of 2)

## 5.2 G-2425G-A general description

G-2425G-A indoor ONTs provide the subscriber interface for the network by terminating the PON interface and converting it to user interfaces that directly connect to subscriber devices.

The G-2425G-A has built-in Wi-Fi 802.11 b/g/n/ac networking with triple play capability and can provide triple play services with voice, video and data.

The ONT is compatible with all existing subscriber equipment, including analog phones with both tone and rotary dial capabilities, cordless phones, modems, fax machines, and caller ID boxes (Type I, Type II, and Type III).

The ONT can be placed on a flat surface, such as a desk or shelf.

Figure 14 shows the G-2425G-A ONT.

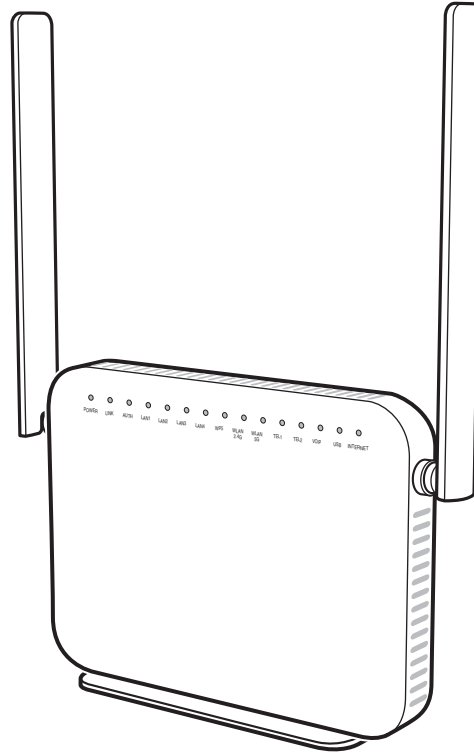
**Figure 14 G-2425G-A ONT**

35646

G-2425G-A indoor ONTs provide the following functions:

- Dual-band concurrent 2x2 IEEE 802.11b/g/n 2.4 GHz and 802.11ac MIMO 5 GHz
- Supports 802.11 b/g/n 2x2 Wireless 2.4 GHz MIMO; Channel bandwidth 20, 40 MHz, auto
- Supports 802.11ac 2x2 Wireless 5 GHz Mu-MIMO; Channel bandwidth 20, 40, 80 MHz, auto
- Four Gigabit standard RJ-45 10/100/1000 Mbps, auto negotiating Ethernet ports and MDI/MDIX auto sensing
- Two POTS ports with R-J11 connectors
- Two USB 2.0 Type A ports
- GPON uplink: G.984 and G.988 series standard compliant
- 256MB NAND Flash with bad block management, 512MB DDR3 RAM, pin2pin compatible design for possible upgrade of RAM/Flash
- WLAN on/off push button
- WPS on/off push button
- LEDs on/off push button
- Reset button



- 
- Triple-Play services, including voice, video and high speed Internet access
  - Support for fax services
  - Built-in layer 2 switch; Line Rate L2 traffic
  - IP video distribution
  - Wavelength: 1490 nm downstream; 1310 nm upstream
  - PHY rate: 300 Mbps for 2.4 G and 867 Mbps for 5 G
  - External antennas with 5dBi gain for each
  - Optics that support received signal strength indication (RSSI)
  - 64/128 WEP encryption
  - WPA, WPA-PSK/TKIP
  - WPA2, WPA2-PSK/AES
  - VLAN tagging/detagging and marking/remarking of IEEE 802.1p per Ethernet port.
  - Dying gasp support
  - Voice Services via Session Initiation Protocol (SIP)
  - Multiple voice Code
  - DTMF dialing
  - Echo cancellation (G.168)
  - Fax mode configuration (T.30/T.38)
  - Caller ID, call waiting, call hold, 3-way calling, call transfer, message waiting
  - Forward Error Correction (FEC)
  - support for multiple SSIDs (private and public instances); contact your Nokia representative for further details.
  - Conductive power: 250mW/24 dBm (2.4 GHz); 500 mW/27 dBm (5GHz)
  - Maximum effective isotropic radiated power (EIRP): 800mW/29dBm (2.4GHz); 1600mW/32dBm (5GHz)
  - Bridged mode or routed mode per LAN port
  - TR-069 support
  - Ethernet-based Point-to-Point (PPPoE)
  - DHCP client/server
  - DNS server/client
  - DDNS
  - Port forwarding
  - Network Address Translation (NAT)
  - Network Address Port Translation (NAPT)
  - UPnP IGD2.0 support
  - ALG
  - IGMP snooping and proxy (v2/v3)
  - Traffic classification and QoS capability
  - OMCI/TR-069 Web GUI configuration
  - Performance monitoring and alarm reporting
  - Remote software image downloading and activation
  - IP/MAC/URL filter

- Multi-level firewall and ACL
- Econet ONT in mainstream

## 5.2.1 TR-069 parameter support

The G-2425G-A ONT supports the following TR-069 features:

- Host object
- Port forwarding
- Optical parameters
- Object support for optical parameters
- Statistics and troubleshooting
- Diagnostic parameter

### 5.2.1.1 Host object support

The ONT provides host object support for:  
InternetGatewayDevice.LANDevice.Hosts.Host.

### 5.2.1.2 Port forwarding support

The ONT supports the port forwarding of objects via TR-069:

- Application Name
- WAN Port
- LAN Port
- Internal Client
- Protocol
- Enable Mapping
- WAN Connection List

These are the same port forwarding parameters supported in the GUI. For more information, see Table 41 in the chapter “[Configure a G-2425G-A indoor ONT](#)”.

### 5.2.1.3 Optical parameters support

The ONT supports the reading of optical parameters via TR-069:

- laser bias current
- voltage

- temperature
- received signal levels
- lower thresholds

These are the same optical parameters supported in the GUI. For more information, see Table 22 in the chapter [“Configure a G-2425G-A indoor ONT”](#).

#### 5.2.1.4 Object support for WiFi parameters

The ONT supports the status retrieval and configuration of the following Wi-Fi parameters via TR-069:

- channel
- SSID
- password for WPA and WEP
- Tx power (transmission rate in percentage of maximum transmit power)
- WPS

These are the same TR-069 object parameters that are supported in the GUI. For more information, see Tables 28 and 29 in the chapter [“Configure a G-2425G-A indoor ONT”](#).

#### 5.2.1.5 Statistics and troubleshooting support

The ONT supports TR-069 statistics and troubleshooting for LAN, WAN, and WiFi.

For more information, see the Procedure [“Retrieve Residential Gateway \(RG\) troubleshooting counters”](#) in the chapter [“Configure a G-2425G-A indoor ONT”](#).

#### 5.2.1.6 Diagnostic parameter support

The ONT supports the following TR-069 diagnostic parameters:

- TR-143
- IP ping
- traceroute

These are the same diagnostic parameters supported in the GUI. For more information, see the Procedure [“Diagnose WAN connections”](#) in the chapter [“Configure a G-2425G-A indoor ONT”](#).

## 5.2.2 Independent TR69 session with Saas

The prime communication between the Nokia Motive cloud solution and the G-2425G-A ONT is TR-069.

To keep the Nokia solution independent from the carrier's ACS, the ONT can establish an independent TR-069 session with the Saas.

The Saas WiFi Care URL and credentials can be programmed from the carrier's ACS solution, or they can be incorporated in a pre-configuration file.

### 5.2.3 TR69 authentication using TLS and CA certificates

G-2425G-A ONTs support TLS, as well as ACS authentication using SHA-256 pre-installed certificates.

If the URL is set to the https://... format, by default, the connection will use TLS without authentication mode. The ONT can also authenticate the ACS using a pre-installed CA certificate.

### 5.2.4 TR-104 parameter extension support for voice service

A proprietary attribute has been added to the TR-104 Voice Service object structure to enable the ACS to configure the name of the embedded GSIP XML file to be selected.

The TR-104 Voice Service Object is:  
InternetGatewayDevice.Services.VoiceService.{i}.Capabilities.SIP.

The proprietary attribute is: X\_ALU-COM\_XML\_File\_Name\_Path.

### 5.2.5 TR-104 voice-related alarms

The G-2425G-A ONT supports the following four TR-104 voice-related alarms on a per FXS port basis.

These alarms all represent SIP registration failures with an alarm level of MAJOR.

- SIPREGDNS: domain name could not be resolved
- SIPREGAUTH: authentication failed
- SIPREGTO: re-transmissions timed out
- SIPREGERR: error response from the registration server

### 5.2.6 TR-104 parameters for FX line testing

New attributes have been added to the TR-104 Voice Service object structure to enable the ACS to perform line tests. The ONT supports the following electrical line tests:

- hazardous potential
- foreign electrical motive force
- resistive faults
- receiver off-hook test
- ringers test

## 5.2.7 TR-111 support

The G-2425G-A ONT supports TR-111, which extends the WAN Management Protocol defined in TR-069 to enhance the ability to remotely manage LAN devices.

The device-gateway association enables an ACS to identify the associated gateway through which a device is connected.

A connect request via the NAT gateway enables an ACS to initiate a TR-069 session with a device that is operating behind a NAT gateway.

## 5.3 G-2425G-A software and installation feature support

For information on installing or replacing the G-2425G-A see:

- [Install a G-2425G-A indoor ONT](#)
- [Replace a G-2425G-A indoor ONT](#)

For information on the following topics, see the *7368 ISAM ONT Product Overview Guide*:

- ONT and MDU general descriptions of features and functions
- Ethernet interface specifications
- POTS interface specifications
- RSSI specifications
- Wi-Fi specifications
- ONT optical budget
- SLID entry via Ethernet port
- ONT management using an ONT interface

## 5.4 G-2425G-A interfaces and interface capacity

Table 5 describes the supported interfaces and interface capacity for G-2425G-A indoor ONTs.

**Table 5** G-2425G-A indoor ONT interface connection capacity

ONT type and model	Maximum capacity								
	POTS	10/ 100 BASE-T	10/ 100/ 1000 BASE-T	RF video (CATV)	MoCA	VDSL2	E1/T1	Local craft	GPON SC/APC
G-2425G-A <sup>(1)</sup>	2	—	4	—	—	—	—	—	1

Note

(1) The G-2425G-A ONTs provide Wi-Fi service that is enabled and disabled using a Wi-Fi on/off switch.

### 5.4.1 G-2425G-A connections and components

Figure 15 shows the physical connections for G-2425G-A indoor ONTs. One USB port is on the side of the ONT.

**Figure 15** G-2425G-A indoor ONT physical connections (back)

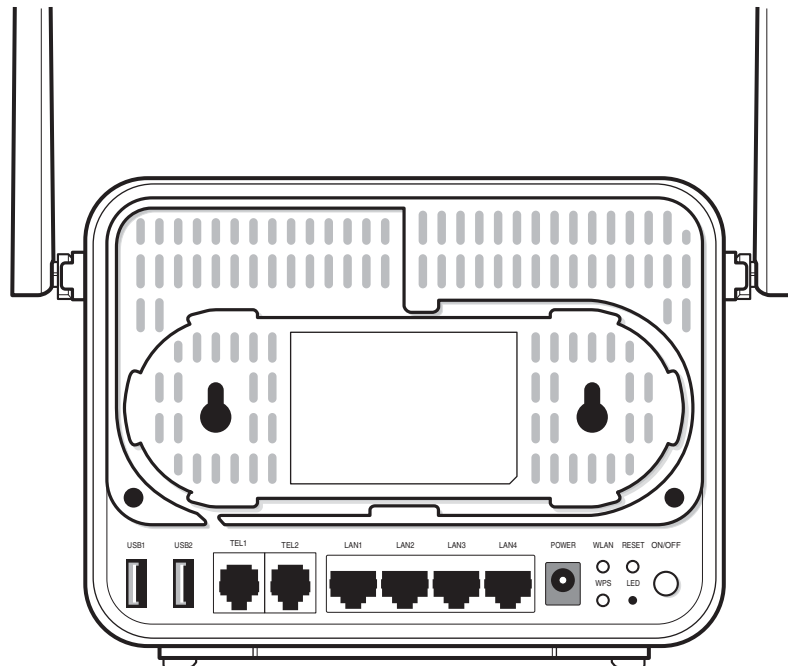

35647

Figure 16 shows the G-2425G-A indoor ONT with a fiber optic connector.

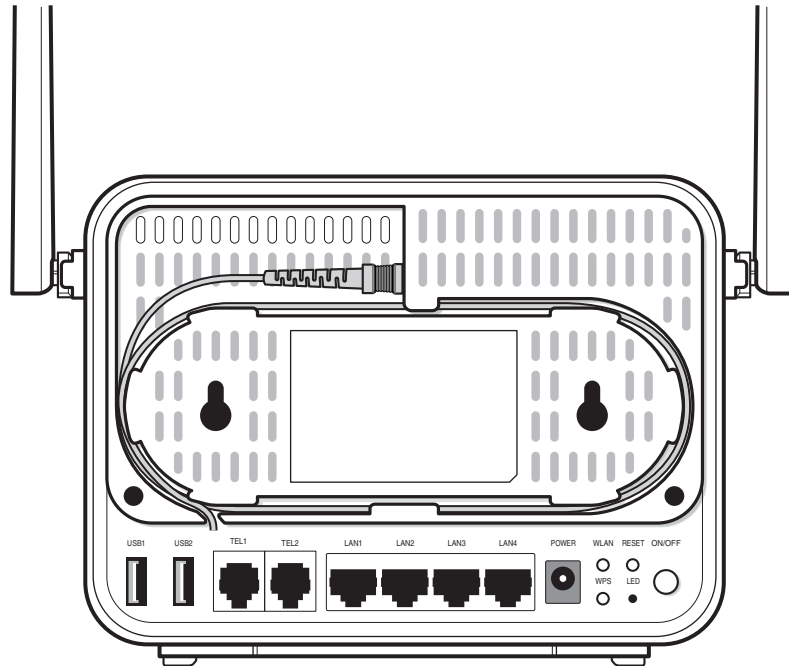
**Figure 16 G-2425G-A indoor ONT with fiber optic connector**

35648

Table 6 describes the physical connections for G-2425G-A indoor ONTs.

**Table 6 G-2425G-A indoor ONT physical connections**

Connection <sup>(1)</sup>	Print Letters	Description
POTS port	TEL1 and TEL2	This connection is provided through an RJ-11 port. One POTS connection is supported. The POTS port supports voice services.
Ethernet ports	LAN1 to LAN4	This connection is provided through Ethernet RJ-45 connectors. Up to four 10/100/1000 Base-T Ethernet interfaces are supported. The Ethernet ports can support both data and in-band video services on all four interfaces.
Power input	POWER	This connection is provided through the power connector. A power cable fitted with a barrel connector is used to make the connection.
Power button	RESET	Power On/Off.
Reset button	WLAN	Pressing the Reset button for less than 10 seconds reboots the ONT; pressing the Reset button for 10 seconds resets the ONT to the factory defaults, except for the LOID and SLID. Accessible through a 2mm pin hole.
WLAN button	WPS	Wi-Fi service is compliant with IEEE 802.11 standards and is enabled and disabled using the WLAN button.
WPS button	LED	The Wi-Fi Protected Setup (WPS) button enables and disables the WPS for 2.4GHz and 5GHz.
LED button	ON/OFF	The LED button turns the LED indicators on or off.

(1 of 2)



Connection <sup>(1)</sup>	Print Letters	Description
On/Off button	USB1 and USB2	This button turns the ONT on or off.
USB port		This connection is provided through 1 USB port on the side of the ONT. The ONT supports external USB hard drives that can be made accessible to all LAN devices.
Fiber optic port	TEL1 and TEL2	The SC/APC fiber optic port is located at the back of the ONT and provides the connection for the fiber optic cable.

(2 of 2)

Note

(1) The primary path for the earth ground for these ONTs is provided by the 12V Return signal in the power connector.

## 5.5 G-2425G-A LEDs

Figure 17 shows the G-2425G-A indoor ONT LEDs.

**Figure 17 G-2425G-A indoor ONT LEDs**

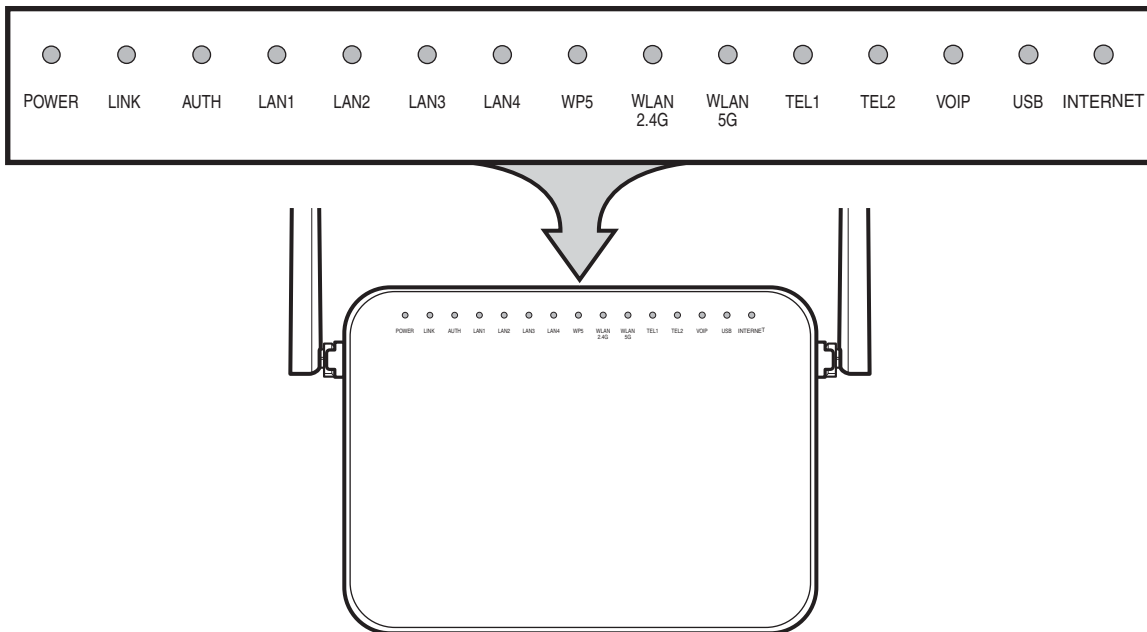

35649

Table 7 provides LED descriptions for G-2425G-A indoor ONTs.

**Table 7 G-2425G-A indoor ONT LED descriptions**

Indicator	LED color and behavior	LED behavior description
Power	Green solid Red solid Off	Power on Light failed on startup (for example corrupt flash), or self test failed on startup, or self test failed during regular operation or when executed over OMCI Power off
Link	Green solid Off	GPON link between ONT and OLT is operating normally GPON link is down or no link is connected
Auth	Off Green solid Green flashing	Fiber is not connected or no power is received to the ONT ONT is configured on the OLT and is in service (UP) ONT is in the process of ranging or synchronizing over the OLT ONT is ranged but not configured on the OLT ONT is configured on OLT but admin is down and the ONT is out of service ONT is in service and subsequently un-configured on the OLT ONT is in service while other services are being configured ONT is in service but admin is down and the ONT is out of service
LAN 1 to 4	Green solid Green flashing Off	ONT is connected to the associated LAN port (includes devices with wake-on-LAN capability where a slight voltage is supplied to an Ethernet connection) LAN activity is present (traffic in either direction) ONT power is off or Ethernet is not connected
TEL 1 to 2	Green solid Green flashing Off	Phone is off hook. Phone is in 'call in' or 'talking' condition All phones are on hook
VOIP	Green solid Off	VoIP service is built up and can provide service VoIP service is not built up or out of service
WPS	Green solid Green flashing Red solid Off	WiFi protected setup link is up (negotiation and auto-configuration successful) WiFi protected setup link activity (negotiation and auto-configuration ongoing) WiFi protected setup processing exception or multiple peers using WPS simultaneously WiFi protected setup link down or no link connected (negotiation has not started or has failed)
WLAN 2.4 GHz	Green solid Green flashing Off	WLAN link is enabled in 2.4 GHz Traffic is passing through the WLAN link WLAN link is disabled or no link is connected
WLAN 5 GHz	Green solid Green flashing Off	WLAN link is enabled in 5 GHz Traffic is passing through the WLAN link WLAN link is disabled or no link is connected
USB	Green solid Green flashing Off	At least one device is connected to the USB port There is traffic activity on at least one device connected to the USB port No device is connected to the USB port

(1 of 2)

Indicator	LED color and behavior	LED behavior description
INTERNET	Green solid  Green flashing  Off	<p>HSI WAN is connected: a) the device has an IP address assigned from IPCP, DHCP, or static, and no traffic has been detected; b) the session is dropped due to idle timeout but the PON link is still present.</p> <p>PPPoE or DHCP connection is in progress, or transmit and receive traffic is ongoing.</p> <p>HSI WAN is not connected: a) there is no physical interface connection; b) the device is in bridged mode without an assigned IP address; c) the session has been dropped for reasons other than idle timeout.</p>

(2 of 2)

## 5.6 G-2425G-A detailed specifications

Table 8 lists the physical specifications for G-2425G-A indoor ONTs.

**Table 8 G-2425G-A indoor ONT physical specifications**

Description	Specification
Length	6.69 in. (170 mm)
Width	1.96 in. (50 mm)
Height (including antenna) (without antenna)	11.81 in. (300 mm) 5.14 in. (130.5 mm)
Weight [within ± 0.5 lb (0.23 kg)] (net weight of ONT)	0.91 lbs (415 g)

Table 9 lists the power consumption specifications for G-2425G-A indoor ONT.

**Table 9 G-2425G-A indoor ONT power consumption specifications**

Mnemonic	Maximum power (Not to exceed)	Condition	Minimum power	Condition
G-2425G-A	24 W	1 POTS off-hook, 4 10/100/1000 Base-T Ethernet, Wi-Fi operational, USB operational	3.6 W	1 POTS on-hook, other interfaces/services not provisioned

Table 10 lists the environmental specifications for G-2425G-A indoor ONT.

**Table 10 G-2425G-A indoor ONT environmental specifications**

Mounting method	Temperature range and humidity	Altitude
On desk or shelf	Operating: 23°F to 113°F (-5°C to 45°C) ambient temperature 5% to 95% relative humidity, non-condensing	Contact your Nokia technical support representative for more information
	Storage: -4°F to 158°F (-20°C to 70°C)	

## 5.7 G-2425G-A GEM ports and T-CONTs

Table 11 lists the maximum number of supported T-CONTs and GEM ports. See the appropriate release Customer Release Notes for the most accurate list of supported devices.

**Table 11 G-2425G-A indoor ONT capacity for GEM ports and T-CONTs**

ONT or MDU	Maximum	Notes
<b>Package P ONTs</b>		
GEM ports per indoor or outdoor ONT	256	256 are present; 254 are available, and 2 are reserved for multicast and debugging
T-CONTs per indoor or outdoor ONT	32	32 are present; 31 are available, and 1 is reserved for OMCI

## 5.8 G-2425G-A performance monitoring statistics

The following section identifies the supported performance monitoring statistics for G-2425G-A ONTs. A check mark indicates the statistic is supported on that ONT. An empty cell indicates the statistic is not supported. The following tables are categorized by supported alarm types:

- Table 12 provides statistics for ONTENET type counters
- Table 13 provides statistics for ONTL2UNI type counters

- Table 14 provides statistics for PONONTTC, PONONTMCTC, PONONTTCHSI, PONONTTCCES, PONONTTCFLOW, and PONONTTCVOIP type counters
- Table 15 provides statistics for PONONTTC aggregate type counters



**Note** — If you have trouble accessing G-2425G-A ONTs performance monitoring statistics using TL1, please contact your Nokia support representative for more information about how to access and retrieve performance monitoring type counters.

**Table 12 Package S ONTs ONTENET performance monitoring statistics**

ONT	ONTENET statistics													
	FCSE	EC	LC	RBO	SCF	MCF	DT	IMTE	CSE	AE	IMRE	FTL	TBO	SQE
G-2425G-A (1)	?	?	?	?	?	?	?	?	?	?	?	?(2)	?	?

**Note**

- (1) A 5 second polling window limitation exists on the ONT, therefore the margin of error for each 15-min window is 5 seconds
- (2) Only packets larger than 9 kB will be counted.

**Table 13 Package S ONTs ONTL2UNI performance monitoring statistics**

ONT	ONTL2UNI statistics										
	FRAMES	BYTES	MCFRAMES	DSDRPDFRMS	USDRPDFRMS	USFRAMES	DSFRAMES	USBYTES	DSBYTES	USMCFRAMES	DSMCFRAMES
G-2425G-A (1)	?	?	?	?	?	?	?	?	?	?	?

**Note**

- (1) A 5 second polling window limitation exists on the ONT, therefore the margin of error for each 15-min window is 5 seconds

**Table 14** Package S ONTs PONONTTC, PONONTMCTC, PONONTTCHSI, PONONTTCCES, PONONTTCFLOW, PONONTTCVOIP performance monitoring statistics

ONT	PONONTTC, PONONTMCTC, PONONTTCHSI, PONONTTCCES, PONONTTCFLOW, PONONTTCVOIP statistics					
	TXBLOCKS	TXFRAGS	RXBLOCKS	RXFRAGS	LOSTFRAGS	BADGEMHDRS
G-2425G-A <sup>(1)</sup>	?	?	?	?	?	

Note

<sup>(1)</sup> A 5 second polling window limitation exists on the ONT, therefore the margin of error for each 15-min window is 5 seconds

**Table 15** Package S ONTs PONONTTC aggregate performance monitoring statistics

ONT	PONONTTC (aggregate) statistics					
	TXBLOCKS	TXFRAGS	RXBLOCKS	RXFRAGS	LOSTFRAGS	BADGEMHDRS
G-2425G-A <sup>(1)</sup>	?	?	?	?	?	

Note

<sup>(1)</sup> A 5 second polling window limitation exists on the ONT, therefore the margin of error for each 15-min window is 5 seconds

## 5.9 G-2425G-A functional blocks

G-2425G-A indoor ONTs are single-residence ONTs that support Wireless (Wi-Fi) service. Wi-Fi service on these ONTs is compliant with the IEEE 802.11 standard and enabled or disabled using a WLAN button. In addition to the Wi-Fi service, these ONTs transmit Ethernet packets to four RJ-45 Ethernet ports and voice traffic to one RJ-11 POTS port. These ONTs also feature fiber optic, USB, and power connectors.

Figure 18 shows the functional blocks for G-2425G-A indoor ONT.

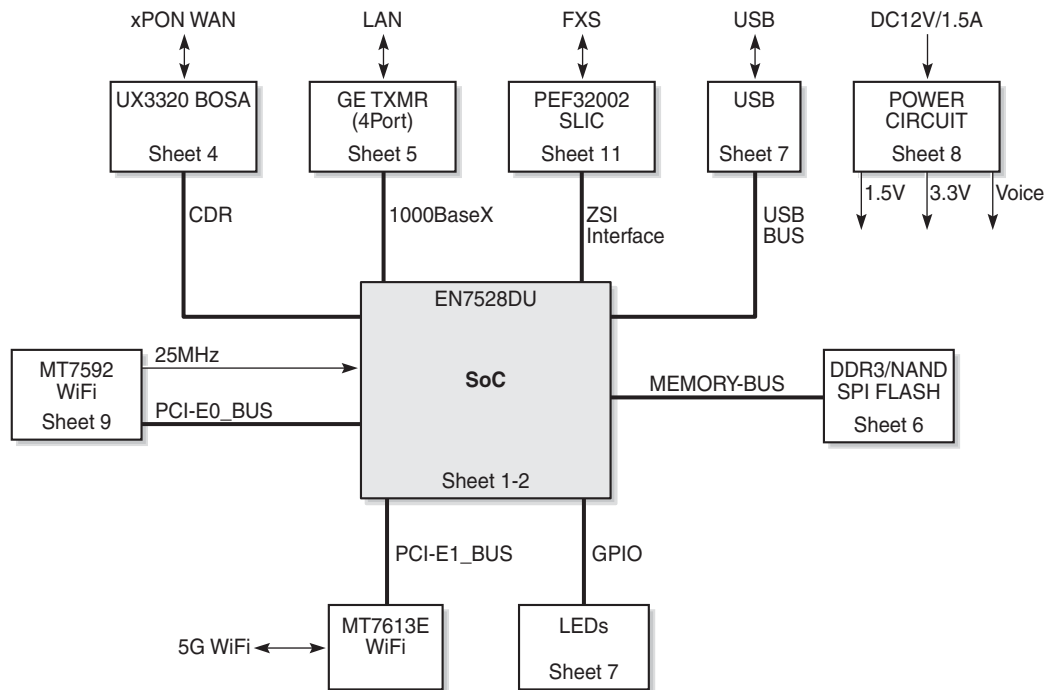
**Figure 18 G-2425G-A ONT functional block**

35650

## 5.10 G-2425G-A standards compliance

G-2425G-A indoor ONTs are compliant with the following standards:

- CE marking for European standards for health, safety, and environmental protection
- EN 300-328 v1.9.1 wide band data transmission standards for 2.4GHz bands
- G.984 support GPON interface (framing)
- G.984.2 (Amd1, class B+) for GPON
- G.984.3 support for activation and password functions
- G.984.3 support for AES with operator enable/disable on per port-ID level
- G.984.3 support for dynamic bandwidth reporting
- G.984.3 support for FEC in both upstream and downstream directions
- G.984.3 support for multicast using a single GEM Port-ID for all video traffic
- G.984.4 and G.983.2 support for ONT management and provisioning
- IEEE 802.1p for traffic prioritization
- IEEE 802.1q for VLANs
- IEEE 802.3 (2012)

- IEEE 802.11 ac/b/g/n for Wi-Fi
- ITU-T G.711, G.722, G.723, G.726, G.729
- SIP RFC 3261

### 5.10.1 Energy-related products standby and off modes compliance

Hereby, Nokia declares that the G-2425G-A ONTs are in compliance with the essential requirements and other relevant provisions of Directive 2009/125/EC together with Commission Regulation (EC) No 1275/2008 and Commission Regulation (EC) No 801/2013.

The G-2425G-A ONTS qualify as equipment with high network availability (HiNA) functionality. Since the main purpose of G-2425G-A ONTs is to provide network functionality with HiNA 7 days /24 hours, the modes Off/Standby, Power Management, and Networked Standby are inappropriate.

For information about the type and number of network ports, see [“G-2425G-A interfaces and interface capacity”](#) in this chapter.

For information about power consumption, see [“G-2425G-A detailed specifications”](#) in this chapter.

### 5.10.2 FCC statement

This equipment has been tested and found to comply with the limits for a Class B digital device, pursuant to part 15 of the FCC Rules. These limits are designed to provide reasonable protection against harmful interference in a residential installation. This equipment generates, uses and can radiate radio frequency energy and, if not installed and used in accordance with the instructions, may cause harmful interference to radio communications. However, there is no guarantee that interference will not occur in a particular installation. If this equipment does cause harmful interference to radio or television reception, which can be determined by turning the equipment off and on, the user is encouraged to try to correct the interference by one or more of the following measures:

- Reorient or relocate the receiving antenna.
- Increase the separation between the equipment and receiver.
- Connect the equipment into an outlet on a circuit different from that to which the receiver is connected.
- Consult the dealer or an experienced radio/TV technician for help.



### 5.10.3 FCC Radiation Exposure Statement

This device complies with FCC radiation exposure limits set forth for an uncontrolled environment and it also complies with Part 15 of the FCC RF Rules. This equipment must be installed and operated in accordance with provided instructions and the antenna(s) used for this transmitter must be installed to provide a separation distance of at least 20 cm from all persons and must not be co-located or operating in conjunction with any other antenna or transmitter. End-users and installers must be provided with antenna installation instructions and consider removing the no-collocation statement.

This device complies with Part 15 of the FCC Rules. Operation is subject to the following two conditions:

- 1 this device may not cause harmful interference, and
- 2 this device must accept any interference received, including interference that may cause undesired operation.



**Caution** — Any changes or modifications not expressly approved by the party responsible for compliance could void the user's authority to operate the equipment.

## 5.11 G-2425G-A special considerations

G-2425G-A is a package P ONT.

### 5.11.1 Wi-Fi service

G-2425G-A indoor ONTs feature Wi-Fi service as well as voice and data services. Wi-Fi is a wireless networking technology that uses radio waves to provide wireless HSI and network connections. This ONT complies with the IEEE 802.11 standards, which the Wi-Fi Alliance defines as the basis for Wi-Fi technology.

#### 5.11.1.1 Wi-Fi physical features

G-2425G-A indoor ONTs have the following physical features that assist in providing Wi-Fi service:

- 1 WLAN button for enabling and disabling Wi-Fi service
- 1 Wi-Fi Protected Setup (WPS) push button for adding WPS-enabled wireless devices
- 4 internal antennas: 2 for 2.4G and 2 for 5G

### 5.11.1.2 Wi-Fi standards and certifications

The Wi-Fi service on G-2425G-A indoor ONTs supports the following IEEE standards and Wi-Fi Alliance certifications:

- certified for IEEE 802.11ac/b/g/n/standards
- WPA support including WPA-PSK
- certified for WPA2-Personal

### 5.11.1.3 Wi-Fi GUI features

G-2425G-A indoor ONTs have HTML-based Wi-Fi configuration GUIs.

## 5.11.2 G-2425G-A ONT considerations and limitations

Table 16 lists the considerations and limitations for Package P G-2425G-A ONTs.

**Table 16 G-2425G-A ONT considerations and limitations**

Considerations and limitations
Call History Data collection (ONTCALLHST) is supported, except for the following parameters: RTP packets (discarded), far-end RTCP and RTCP-XR participation, RTCP average and peak round trip delay, MOS, average jitter, number of jitter-buffer over-runs and under runs.
Some voice features are configurable on a per ONT basis, including Call Waiting, Call Hold, 3-Way Calling, and Call Transfer.
The following voice features / GSIP parameters are configurable on a per-Client/ per-ONT basis (not per-Subscriber): <ul style="list-style-type: none"> <li>• Enable Caller ID and Enable Caller Name ID</li> <li>• Digitmap and the associated Interdigit and Critical timers and Enter key parameters</li> <li>• Warmline timer is enabled per subscriber, but the warmline timer value is configured per ONT and must have a lower value than the Permanent time</li> <li>• Miscellaneous timers: Permanent, Timed-release, Reanswer, Error-tone, and CW-alert timers</li> <li>• Features / functions: Message waiting mode, WMWI refresh interval, DTMF volume level</li> <li>• Service Codes for the following features: CW, Call Hold and Warmline</li> </ul>

---

# 6 Install a G-2425G-A indoor ONT

## 6.1 Purpose

## 6.2 General

## 6.3 Prerequisites

## 6.4 Recommended tools

## 6.5 Safety information

## 6.6 Procedure

## 6.1 Purpose

This chapter provides the steps to install a G-2425G-A indoor ONT.

## 6.2 General

The steps listed in this chapter describe mounting and cabling for a G-2425G-A indoor ONT.

## 6.3 Prerequisites

You need the following items before beginning the installation:

- all required cables

## 6.4 Recommended tools

You need the following tools for the installation:

- #2 Phillips screwdriver
- 1/4 in. (6 mm) flat blade screwdriver
- wire strippers
- fiber optic splicing tools
- RJ-45 cable plug crimp tool
- voltmeter or multimeter
- optical power meter

- drill and drill bits
- paper clip

## 6.5 Safety information

Read the following safety information before installing the unit.



**Danger 1** — Hazardous electrical voltages and currents can cause serious physical harm or death. Always use insulated tools and follow proper safety precautions when connecting or disconnecting power circuits.

**Danger 2** — Make sure all sources of power are turned off and have no live voltages present on feed lines or terminals. Use a voltmeter to measure for voltage before proceeding.

**Danger 3** — Always contact the local utility company before connecting the enclosure to the utilities.



**Warning** — This equipment is ESD sensitive. Proper ESD protections should be used when removing the fiber access cover of the indoor ONT.



**Caution** — Keep indoor ONTs out of direct sunlight. Prolonged exposure to direct sunlight can damage the unit.



**Note 1** — Observe the local and national laws and regulations that may be applicable to this installation.

**Note 2** — Observe the following:

- The indoor ONT should be installed in accordance with the applicable requirements of the NEC or CEC. Local authorities and practices take precedent when there is conflict between the local standard and the NEC or CEC.
- The indoor ONT must be installed by qualified service personnel.
- Indoor ONTs must be installed with cables that are suitably rated and listed for indoor use.
- See the detailed specifications in the [“G-2425G-A unit data sheet”](#) for the temperature ranges of these ONTs.

## 6.6 Procedure

Use this procedure to install a G-2425G-A indoor ONT.

- 1 Place the indoor ONT unit on a flat surface, such as a desk or shelf.



**Note** — The G-2425G-A cannot be stacked with another ONT or with other equipment. The ONT mounting requirements are:

- allow a minimum 100 mm clearance above the top cover
- allow a minimum 50 mm clearance from the side vents
- do not place any heat source directly above the top cover or below the bottom cover

- 2 Review the connection locations, as shown in Figure 19.

**Figure 19** G-2425G-A ONT connections

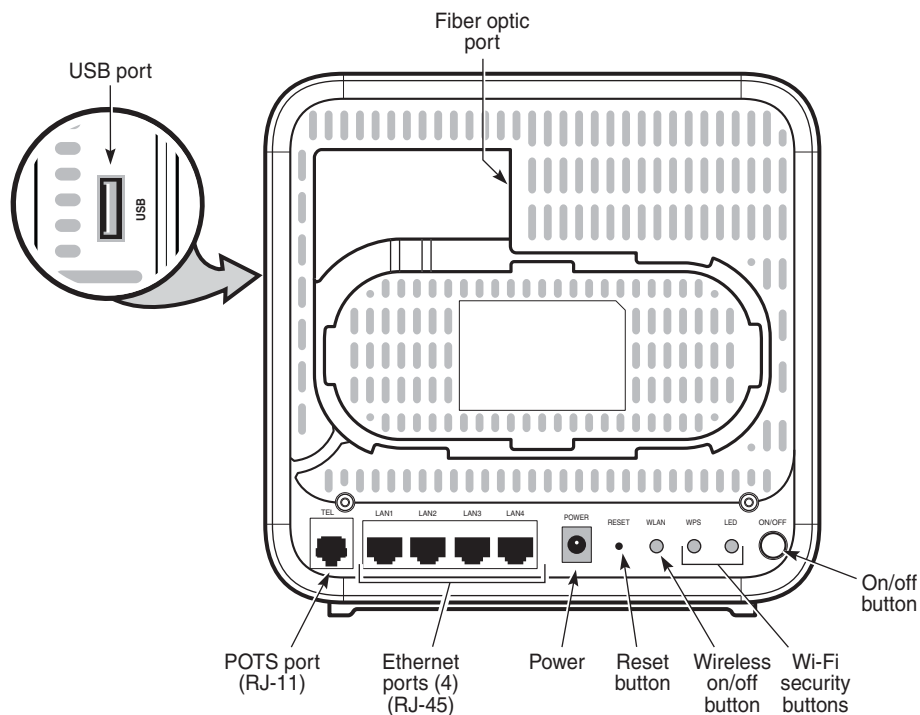

28478

- 3 Connect the Ethernet cables to the RJ-45 ports.
- 4 Route the POTS cable directly to the RJ-11 port as per local practices.

- 
- 5 Connect the fiber optic cable with SC/APC adapter to the SC/APC connector on the bottom of the ONT.



**Danger** — Fiber cables transmit invisible laser light. To avoid eye damage or blindness, never look directly into fibers, connectors, or adapters.



**Warning** — Be careful to maintain a bend radius of no less than 1.5 in. (3.8 cm) when connecting the fiber optic cable. Too small of a bend radius in the cable can result in damage to the optic fiber.



**Note** — Fiber cable preparation varies depending on the type and size of the inside or outside plant fiber cable being spliced to the SC/APC fiber optic pigtail cable.

- 
- 6 Connect the power cable to the power connector.
- 
- 7 Power up the ONT unit by using the power switch.
- 
- 8 If used, enable the Wi-Fi service.
- i Locate the WLAN button on the ONT; see Figure 19 for location of the WLAN button.
  - ii Press the WLAN button to change the status of the Wi-Fi service.
- 
- 9 Verify the ONT LEDs, voltage status, and optical signal levels; see the *7368 Hardware and Cabling Installation Guide*.
- 
- 10 Activate and test the services; see the *7368 Hardware and Cabling Installation Guide*.
- 
- 11 If used, configure the SLID; see the *7368 ISAM ONT Configuration, Management, and Troubleshooting Guide*.
- 
- 12 If necessary, reset the ONT.
- i Locate the Reset button on a G-2425G-A indoor ONT as shown in Figure 19.
  - ii Insert the end of a straightened paper clip or other narrow object into the hole in the Reset button to reset the ONT.
- 
- 13 STOP. This procedure is complete.

---

# 7 Replace a G-2425G-A indoor ONT

## 7.1 Purpose

## 7.2 General

## 7.3 Prerequisites

## 7.4 Recommended tools

## 7.5 Safety information

## 7.6 Procedure

## 7.1 Purpose

This chapter provides the steps to replace a G-2425G-A indoor ONT.

## 7.2 General

The steps listed in this chapter describe mounting and cabling for a G-2425G-A indoor ONT.

## 7.3 Prerequisites

You need the following items before beginning the installation:

- all required cables

## 7.4 Recommended tools

You need the following tools for replacing the ONT:

- #2 Phillips screwdriver
- 1/4 in. (6 mm) flat blade screwdriver
- wire strippers
- fiber optic splicing tools
- RJ-45 cable plug crimp tool
- voltmeter or multimeter

- optical power meter
- drill and drill bits

## 7.5 Safety information

Read the following safety information before replacing the unit.



**Danger 1** — Hazardous electrical voltages and currents can cause serious physical harm or death. Always use insulated tools and follow proper safety precautions when connecting or disconnecting power circuits.

**Danger 2** — Make sure all sources of power are turned off and have no live voltages present on feed lines or terminals. Use a voltmeter to measure for voltage before proceeding.

**Danger 3** — Always contact the local utility company before connecting the enclosure to the utilities.



**Warning** — This equipment is ESD sensitive. Proper ESD protections should be used when removing the fiber access cover of the indoor ONT.



**Caution** — Keep indoor ONTs out of direct sunlight. Prolonged exposure to direct sunlight can damage the unit.



**Note 1** — Observe the local and national laws and regulations that may be applicable to this installation.

**Note 2** — Observe the following:

- The indoor ONT should be installed in accordance with the applicable requirements of the NEC or CEC. Local authorities and practices take precedent when there is conflict between the local standard and the NEC or CEC.
- The indoor ONT must be installed by qualified service personnel.
- Indoor ONTs must be installed with cables that are suitably rated and listed for indoor use.
- See the detailed specifications in the [“G-2425G-A unit data sheet”](#) for the temperature ranges of these ONTs.



---

## 7.6 Procedure

Use this procedure to replace a G-2425G-A indoor ONT.

---

**1** Deactivate the ONT services at the P-OLT.

If you are using the SLID feature, this step is not required. The ONT and the services can remain in service (IS).

- i** Use the RTRV-ONT command to verify the ONT status and th associated services. Record the serial number or the SLID of the ONT displayed in the command output.

Example:

```
RTRV-ONT: :ONT-1-1-1-1-1;
```

- ii** If the ONT is in service, place the ONT in OOS state.

Example:

```
ED-ONT: :ONT-1-1-1-1-1;
```

---

**2** If used, disable the Wi-Fi service by pressing the WLAN button; see [Figure 20](#) for the location of the WLAN button.

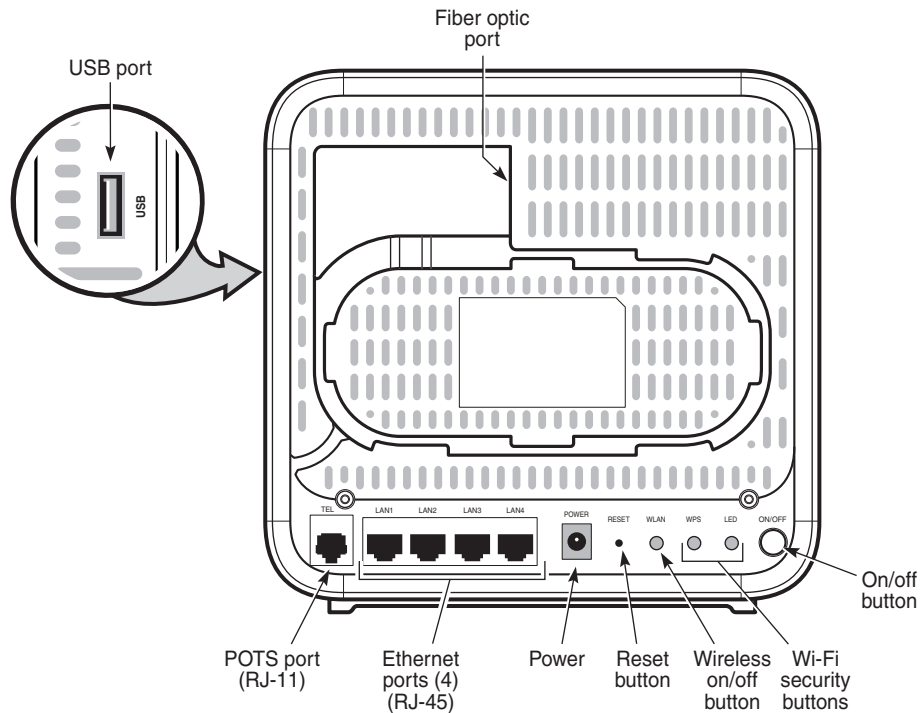
**Figure 20** G-2425G-A indoor ONT connections

28478

- 3 Power down the unit by using the on/off power switch.
- 4 Disconnect the POTS, Ethernet, and power cables from the ONT; see Figure 20 for the connector locations on the G-2425G-A indoor ONT.
- 5 Disconnect the fiber optic cables.
  - Danger** — Fiber cables transmit invisible laser light. To avoid eye damage or blindness, never look directly into fibers, connectors, or adapters.
  - i Unplug the fiber optic cable with SC/APC connector from the bottom of the ONT.
  - ii Attach a fiber dust cover to the end of the SC/APC connector.
- 6 Replace the old ONT with a new ONT on a flat surface, such as a desk or shelf.
- 7 Connect the Ethernet cables directly to the RJ-45 ports; see Figure 20 for the location of the RJ-45 ports.

---

**8** Connect the POTS cable directly to the RJ-11 port as per local practices; see Figure 20 for the location of the RJ-11 ports.

---

**9** If required, have approved service personnel who are trained to work with optic fiber clean the fiber optic connection. See the *7368 ISAM ONT Configuration, Management, and Troubleshooting Guide* for more information about fiber optic handling, inspection, and cleaning.



**Danger** — Fiber optic cables transmit invisible laser light. To avoid eye damage or blindness, never look directly into fibers, connectors, or adapters.

---

**10** Connect the fiber optic cable with SC/APC adapter into the SC/APC connector on the bottom of the ONT.



**Danger** — Fiber cables transmit invisible laser light. To avoid eye damage or blindness, never look directly into fibers, connectors, or adapters.



**Warning** — Be careful to maintain a bend radius of no less than 1.5 in. (3.8 cm) when connecting the fiber optic cable. Too small of a bend radius in the cable can result in damage to the optic fiber.



**Note** — Fiber cable preparation varies depending on the type and size of the inside or outside plant fiber cable being spliced to the SC/APC fiber optic pigtail cable.

---

**11** Connect the power cable to the power connector.

---

**12** Power up the unit by using the power switch.

---

**13** If used, enable the Wi-Fi service by pressing the WLAN button; see Figure 20 for the location of the WLAN button.

- 14** If used, configure the SLID; see the *7368 ISAM ONT Configuration, Management, and Troubleshooting Guide* for more information.



**Note** — A new SLID or the old SLID may be used with the replacement ONT.

If a new SLID is used, the new SLID must also be programmed at the P-OLT using TL1 or a network manager.

If the old SLID is used, no changes need to be made at the P-OLT; see the operations and maintenance documentation for the OLT for more details.

- 
- 15** Verify the ONT LEDs, voltage status, and optical signal levels; see the *7368 Hardware and Cabling Installation Guide*.

- 
- 16** Activate and test the services; see the *7368 Hardware and Cabling Installation Guide*.

- 
- 17** If necessary, reset the ONT.

- i** Locate the Reset button on a G-2425G-A indoor ONT as shown in [Figure 20](#).
- ii** Insert the end of a straightened paper clip or other narrow object into the hole in the Reset button to reset the ONT.

- 
- 18** STOP. This procedure is complete.

---

# 8 Configure a G-2425G-A indoor ONT

## 8.1 General

### 8.2 HGU mode GUI configuration

## 8.1 General

Please refer to the configuration information provided with your OLT for the software configuration procedure for a G-2425G-A ONT.

For HTTP configuration procedures, please refer to the *7368 ISAM ONT Configuration, Management, and Troubleshooting Guide*.

## 8.2 HGU mode GUI configuration

Use the procedures below to use the web-based GUI for the G-2425G-A in HGU mode. This mode is preset at delivery.

A home gateway unit (HGU) is a home networking device, used as a gateway to connect devices in the home through fiber to the Internet. An HGU provides a variety of features for the home network including routing and firewall capability. By using the HGU, users can connect all smart equipment in their home, including personal computers, set-top boxes, mobile phones, and other consumer electronics devices, to the Internet.

### 8.2.1 Login

Use the procedure below to login to the web-based GUI for the G-2425G-A.

#### Procedure 6 Login to web-based GUI

- 
- 1 Open a web browser and enter the IP address of the ONT in the address bar.

The login window appears.

The default gateway IP address is `http://192.168.1.254`. You can connect to this IP address using your web browser after connecting your PC to one of Ethernet ports of the ONT. The static IP address of your PC must be in the same 192.168.1.x subnet as the ONT.

- 
- 2 Enter your username and password in the Log in window, as shown in Figure 21.

The default user name is AdminGPON. The default password is ALC#FGU

**Figure 21 Web login window**



**Caution** — Pressing the Reset button for less than 10 seconds reboots the ONT; pressing the Reset button for 10 seconds resets the ONT to the factory defaults, except for the LOID and SLID.



**Note** — If you forget the current username and password, press the reset button for 5 seconds and the default values for the username and password will be recovered at startup.

- 
- 3 Click Login. The Device Information screen appears.



**Note** — To help protect the security of your Internet connection, the application displays a pop-up reminder to change both the Wi-Fi password and the ONT password.

To increase password security, use a minimum of 10 characters, consisting of a mix of numbers and upper and lower case letters.

- 
- 4 STOP. This procedure is complete.
- 

## 8.2.2 Device and connection status

G-2425G-A ONTs support the retrieval of a variety of device and connection information, including:

- device information
- LAN status

- WAN status
- WAN status IPv6
- Home networking information
- optics module status
- voice information

**Procedure 7 Device information retrieval**

- 1 Select Status > Device Information from the top-level menu in the GPON Home Gateway window, as shown in Figure 22.

**Figure 22 Device Information window**

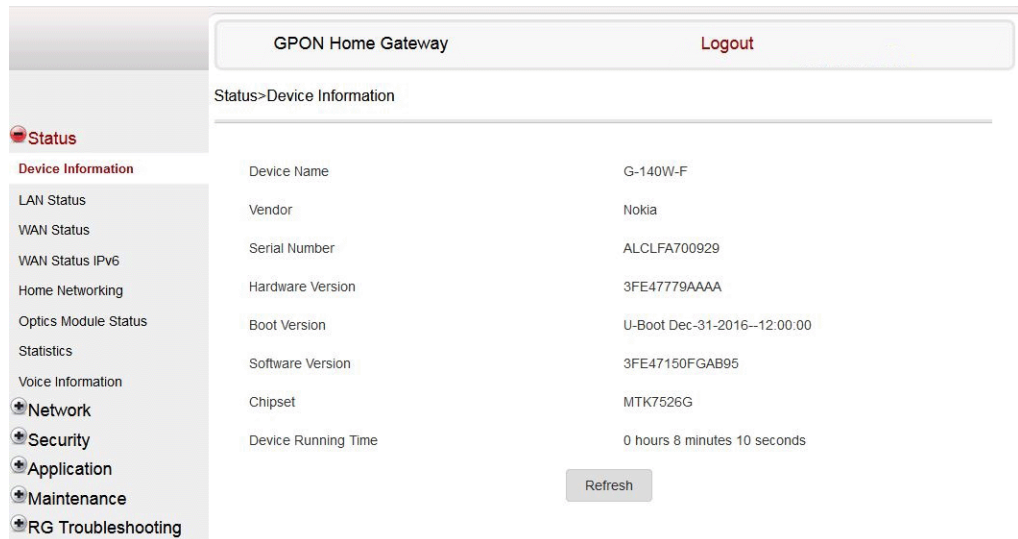

**Note** — Upon login, the GPON Home Gateway window displays the WAN status block on the bottom left part of each window. This block shows the WAN connection ID, the WAN status, and any WAN errors.

This block is accurate upon login, but it is static; click the Refresh button to update the information.

Table 17 describes the fields in the Device Information window.

**Table 17 Device Information parameters**

Field	Description
Device Name	Name on the ONT

(1 of 2)

Field	Description
Vendor	Name of the vendor
Serial Number	Serial number of the ONT
Hardware version	Hardware version of the ONT
Boot version	Boot version of the ONT
Software version	Software version of the ONT
Chipset	Chipset of the ONT
Device Running Time	Amount of time the device has run since last reset in hours, minutes, and seconds

**(2 of 2)**

---

**2** Click Refresh to update the displayed information.

---

**3** STOP. This procedure is complete.

---



## Procedure 8 LAN status retrieval

- 1 Select Status > LAN Status from the top-level menu in the GPON Home Gateway window, as shown in Figure 23.

**Figure 23 LAN status window**

Table 18 describes the fields in the LAN status window.

**Table 18 LAN status parameters**

Field	Description
<b>Wireless Information</b>	
Wireless Status	Indicates whether the wireless is on or off
Wireless Channel	Wireless channel number
SSID Name	Name of each SSID

(1 of 2)

---

Field	Description
Wireless Encryption Status	Encryption type used on the wireless connection
Wireless Rx Packets	Number of packets received on the wireless connection
Wireless Tx Packets	Number of packets transmitted on the wireless connection
Wireless Rx Bytes	Number of bytes received on the wireless connection
Wireless Tx Bytes	Number of bytes transmitted on the wireless connection
Power Transmission (mW)	Power of the wireless transmission, in mW
<b>Ethernet Information</b>	
Ethernet Status	Indicates whether the Ethernet connection is on or off
Ethernet IP Address	IP address of the Ethernet connection
Ethernet Subnet Mask	Subnet Mask of the Ethernet connection
Ethernet MAC Address	MAC address of the Ethernet connection
Ethernet Rx Packets	Number of packets received on the Ethernet connection
Ethernet Tx Packets	Number of packets transmitted on the Ethernet connection
Ethernet Rx Bytes	Number of bytes received on the Ethernet connection
Ethernet Tx Bytes	Number of bytes transmitted on the Ethernet connection

(2 of 2)

---

**2** Click Refresh to update the displayed information.

---

**3** STOP. This procedure is complete.

---

## Procedure 9 WAN status retrieval

- 1 Select Status > WAN Status from the top-level menu in the GPON Home Gateway window, as shown in Figure 24.

**Figure 24** WAN status window

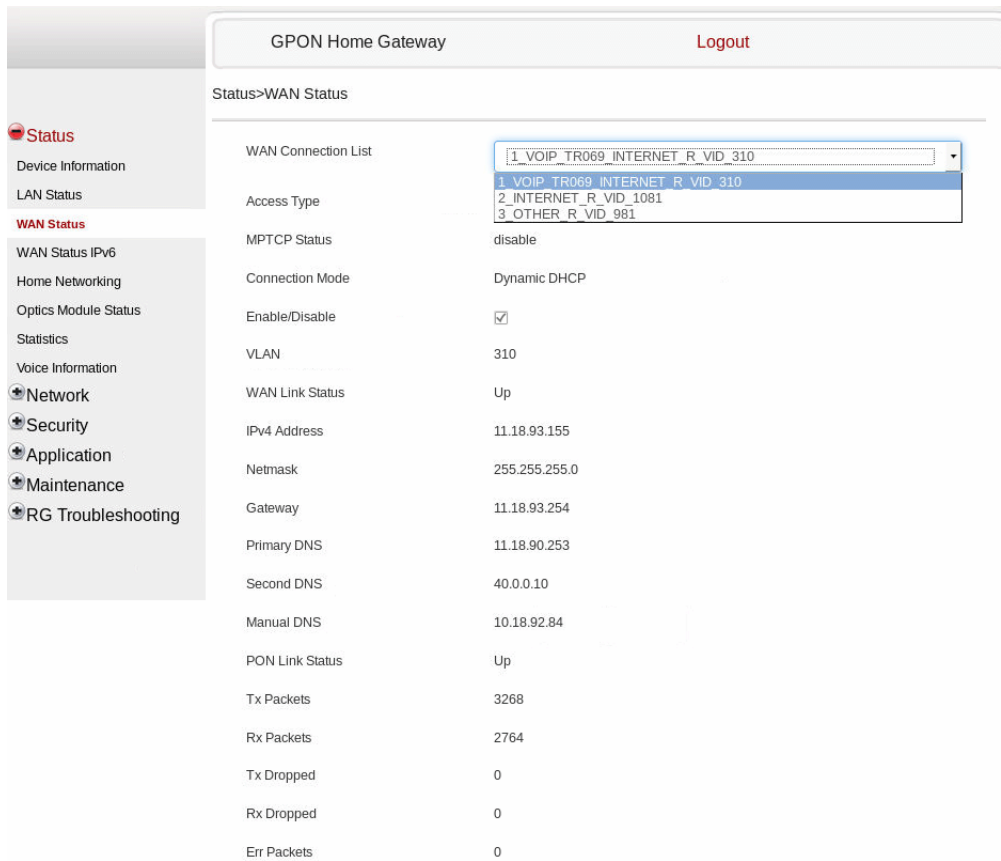

Table 19 describes the fields in the WAN status window.

**Table 19** WAN status parameters

Field	Description
WAN Connection List	Drop-down menu listing all WAN connections. The connection shown is the connection for which WAN status will be shown.
MPTCP Status	Enables or disables the MPTCP status
Connection Mode	Connection mode of the WAN connection
Enable/Disable	Select this checkbox to enable or disable the WAN connection
VLAN	VLAN ID

(1 of 2)

---

Field	Description
WAN Link Status	Whether the WAN link is up or down
IPv4 Address	IP Address of the ONT
Netmask	Network mask
Gateway	Gateway address
Primary DNS	Primary Domain Name Server
Second DNS	Secondary Domain Name Server
Manual DNS	Manual Domain Name Server
PON Link Status	Whether the PON link is up or down
Tx Packets	Number of packets transmitted on the WAN connection
Rx Packets	Number of packets received on the WAN connection
Tx Dropped	Number of packets dropped on the transmit WAN connection
Rx Dropped	Number of packets dropped on the receive WAN connection
Err Packets	Number of errored packets on the WAN connection

**(2 of 2)**

---

**2** Click Refresh to update the displayed information.

---

**3** STOP. This procedure is complete.

---

## Procedure 10 WAN status IPv6 retrieval

- 1 Select Status > WAN Status IPv6 from the top-level menu in the GPON Home Gateway window, as shown in Figure 25.

**Figure 25** WAN status IPv6 window

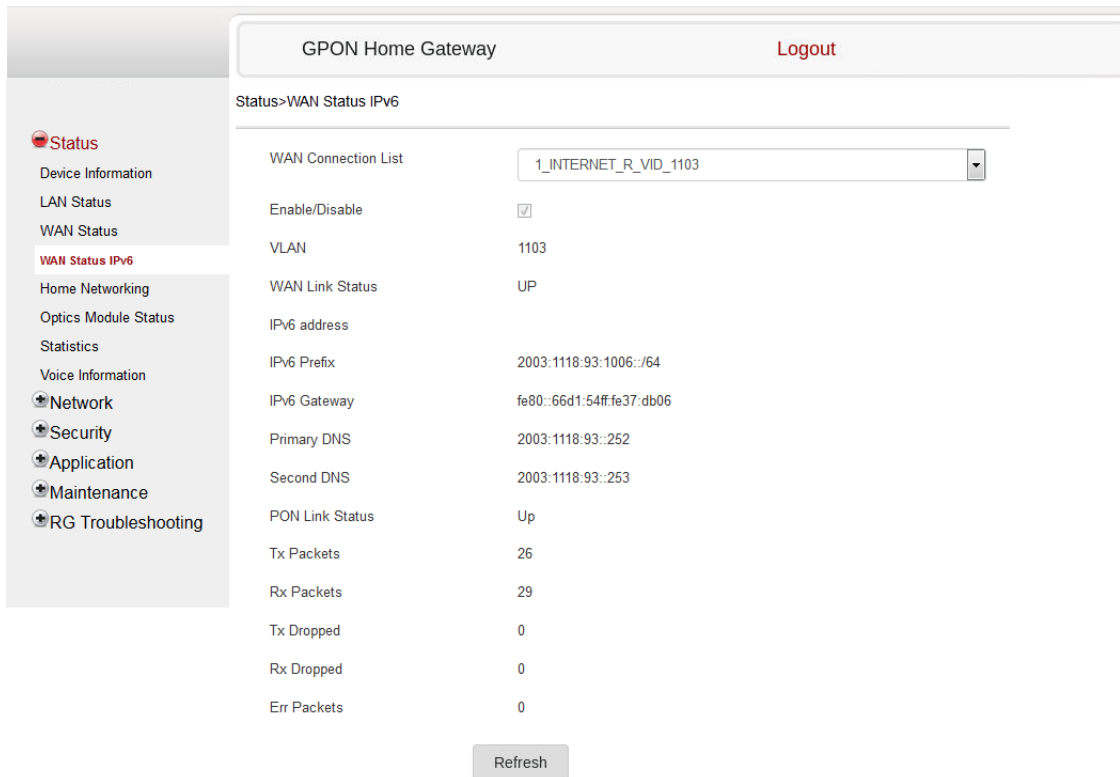

Table 20 describes the fields in the WAN status IPv6 window.

**Table 20** WAN status IPv6 parameters

Field	Description
WAN Connection List	Drop-down menu listing all WAN connections. The connection shown is the connection for which WAN status will be shown.
Enable/Disable	Select this checkbox to enable the WAN connection
VLAN	VLAN ID
WAN Link Status	Whether the WAN link is up or down
IPv6 Address	IPv6 address that identifies the device and its location
IPv6 Prefix	IPv6 prefix
IPv6 Gateway	IPv6 gateway address

(1 of 2)

---

Field	Description
Primary DNS	Primary Domain Name Server
Second DNS	Secondary Domain Name Server
PON Link Status	Whether the PON link is up or down
Tx Packets	Number of packets transmitted on the WAN connection
Rx Packets	Number of packets received on the WAN connection
Tx Dropped	Number of packets dropped on the transmit WAN connection
Rx Dropped	Number of packets dropped on the receive WAN connection
Err Packets	Number of errored packets on the WAN connection

(2 of 2)

---

**2** Click Refresh to update the displayed information.

---

**3** STOP. This procedure is complete.

---

## Procedure 11 Home networking information retrieval

- 1 Select Status > Home Networking from the top-level menu in the GPON Home Gateway window, as shown in Figure 26.

**Figure 26** Home networking information window

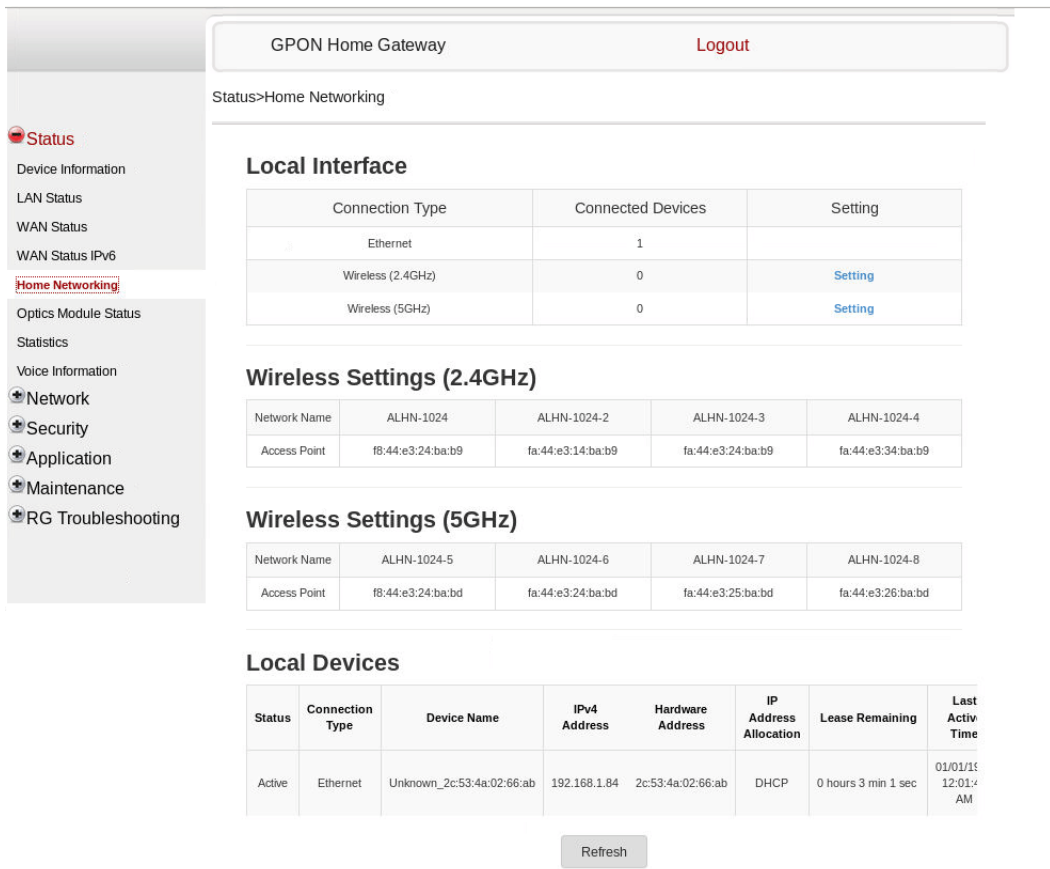

Table 21 describes the fields in the Home networking window.

**Table 21** Home networking parameters

Field	Description
<b>Local Interface</b>	
Ethernet	Table displays the number of Ethernet connections and their settings
Wireless	Table displays the number of wireless connections and their settings (2.4GHz and 5GHz)
<b>Wireless Settings (2.4GHz and 5GHz)</b>	
Network Name	Name of the wireless network

(1 of 2)

Field	Description
Access Point	Hexadecimal address of the wireless access point
<b>Local Devices</b>	
Table entry	Each entry indicates the status (active or inactive), connection type, device name, IP address, hardware address, IP address allocation, lease remaining, and last active time of each connected local device.

(2 of 2)

2 Click Delete to delete a particular local device connection.

3 Click Refresh to update the displayed information.

4 STOP. This procedure is complete.

## Procedure 12 Optics module status retrieval

- 1 Select Status > Optics Module Status from the top-level menu in the GPON Home Gateway window, as shown in Figure 27.

Figure 27 Optics module status window

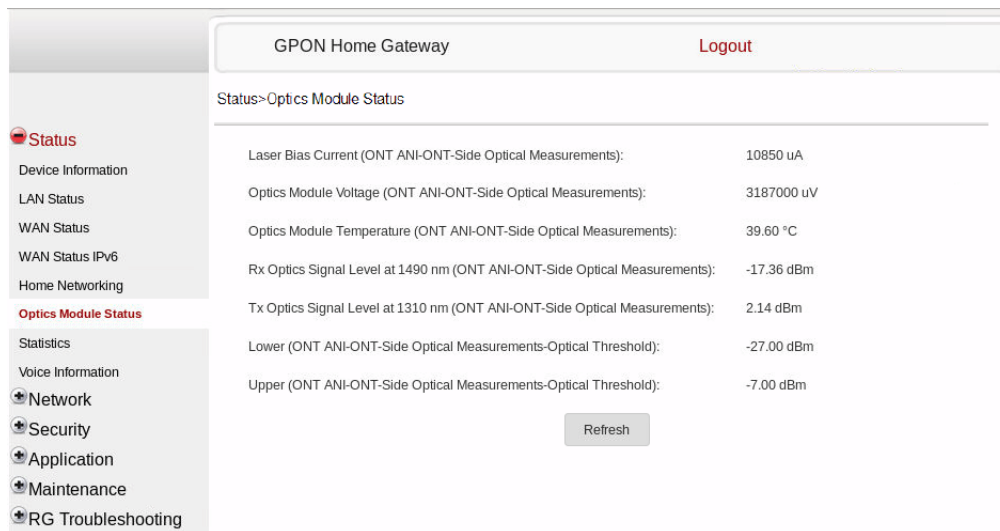

Table 22 describes the fields in the Optics module status window.



**Table 22** Optics module status parameters

Field	Description
Laser Bias Current (ONT ANI-ONT-Side Optical Measurements)	Laser bias current, measured in uA
Optics Module Voltage (ONT ANI-ONT-Side Optical Measurements)	Optics module voltage, measured in V
Optics Module Temperature (ONT ANI-ONT-Side Optical Measurements)	Optics module temperature, measured in C
Rx Optics Signal Level at 1490 nm (ONT ANI-ONT-Side Optical Measurements)	Received optics signal level at 1490 nm, measured in dBm
Tx Optics Signal Level at 1310 nm (ONT ANI-ONT-Side Optical Measurements)	Transmitted optics signal level at 1310 nm, measured in dBm
Lower (ONT ANI-ONT-Side Optical Measurements-Optical Threshold)	Lower optical threshold, measured in dBm
Upper (ONT ANI-ONT-Side Optical Measurements-Optical Threshold)	Upper optical threshold, measured in dBm

---

**2** Click Refresh to update the displayed information.

---

**3** STOP. This procedure is complete.

---

## Procedure 13 Voice information retrieval

- 1 Select Status > Voice Information from the top-level menu in the GPON Home Gateway window, as shown in Figure 28.

**Figure 28** Voice Information window

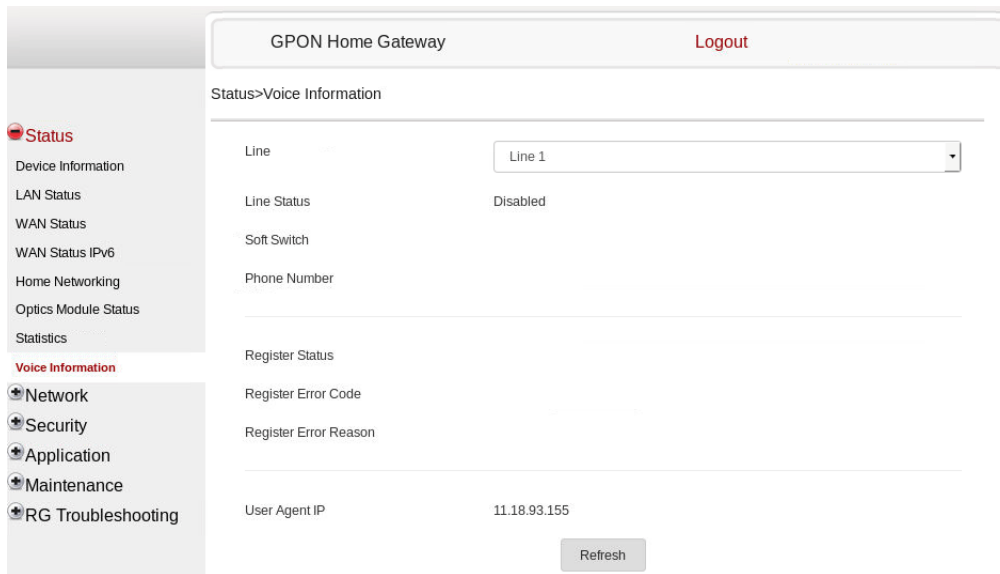

Table 23 describes the fields in the Voice Information window.

**Table 23** Voice Information parameters

Field	Description
Line	Choose a line from the drop-down menu. The default is Line 1.
Line Status	Depending on the line chosen, the line options are: <ul style="list-style-type: none"> <li>• Up</li> <li>• Initializing</li> <li>• Registering</li> <li>• Unregistering</li> <li>• Error</li> <li>• Testing</li> <li>• Quiescent</li> <li>• Disabled</li> </ul> The default is Disabled
Soft Switch <sup>(1)</sup>	Proxy IP address; blank if the line is not registered
Phone number <sup>(1)</sup>	Phone number configured for a telephone line 1; +13290611266

(1 of 2)

Field	Description
Register Status	The default is Registered Blank if no voice service is provisioned
Register Error Code	SIP standard error code for the register status; for example, 401, 403, 503 This field is blank if the register is set to OK
Register Error Reason	SIP standard error reason for the register status This field is blank if the register is set to OK
User Agent IP	IP address of the user agent ExternalIPAddress in WANIPConnection or WANPPPPConnection

**(2 of 2)**

**Note**

<sup>(1)</sup> This field is only visible at the adminPON level; it is not visible at the userAdmin level.

---

**2** Click Refresh to update the displayed information.

---

**3** STOP. This procedure is complete.

---

## 8.2.3 Network configuration

The G-2425G-A ONT supports network configuration, including:

- LAN
- LAN IPv6
- WAN
- WAN DHCP
- WiFi 2.4G
- WiFi 5G
- Wireless schedule
- Routing
- DNS
- TR-069
- QoS

## Procedure 14 LAN networking configuration

- 1 Select Network > LAN from the top-level menu in the GPON Home Gateway window, as shown in Figure 29.

**Figure 29 LAN network window**

Table 24 describes the fields in the LAN network window.

**Table 24 LAN network parameters**

Field	Description
<b>Port Mode</b>	
All Ports to Bridge Mode	Select this checkbox to set all ports to Bridge mode
Port 1 - 4	Drop-down port mode for each port: Route mode or Bridge mode
IPv4 Address	IP Address of the ONT
Subnet Mask	Subnet mask of the ONT
DHCP enable	Select this checkbox to enable DHCP
DHCP Start IP Address	Starting DHCP IP address
DHCP End IP Address	Ending DHCP IP address
DHCP Lease Time	DHCP lease time (in min)
Primary DNS	Primary DNS identifier
Secondary DNS	Secondary DNS identifier
<b>Static DHCP Entry</b>	
MAC Address	MAC address for the static DHCP
IPv4 Address	IPv4 address for the static DHCP

---

**2** Select the mode for each port.

---

**3** Click Save.

---

**4** Enter the DHCP configuration information.

---

**5** Click Save.

---

**6** Enter the Static DHCP information.

---

**7** Click Add.

You can also use this panel to delete a Static DHCP MAC address or IPv4 address.

---

**8** STOP. This procedure is complete.

---

## Procedure 15 LAN IPv6 networking configuration

- 1 Select Network > LAN\_IPv6 from the top-level menu in the GPON Home Gateway window, as shown in Figure 30.

**Figure 30 LAN IPv6 network window**

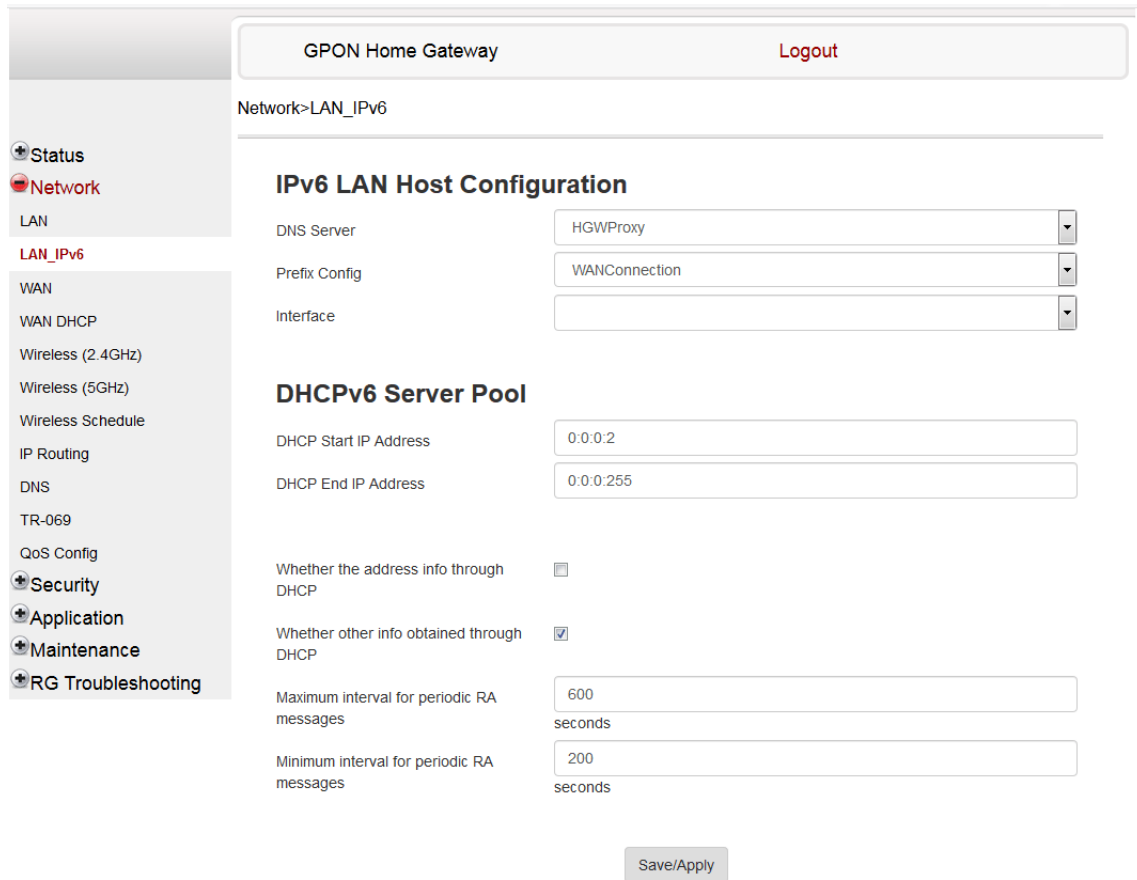

Table 25 describes the fields in the LAN IPv6 network window.

**Table 25 LAN IPv6 network parameters**

Field	Description
<b>IPv6 LAN Host Configuration</b>	
DNS Server	Choose a DNS server from the drop-down menu
Prefix Config	Choose a prefix config option from the drop-down menu, either WANConnection (prefix will be obtained from the WAN) or Static (enables you to enter the prefix).

(1 of 2)

Field	Description
Interface	This field appears if you selected the Wan Connection option for the "prefix config" field. Choose a WAN connection interface from the drop-down menu.
<b>DHCPv6 Server Pool</b>	
DHCP Start IP Address	Enter the starting DHCP IP address
DHCP End IP Address	Enter the ending DHCP IP address
Whether the address info through DHCP	Select this checkbox to enable address information retrieval through DHCP
Whether other info obtained through DHCP	Select this checkbox to enable retrieval of other information through DHCP
Maximum interval for periodic RA messages	Enter the maximum interval (in seconds) for periodic Router Advertisement messages. The interval range is from 4 to 1800.
Minimum interval for periodic RA messages	Enter the minimum interval (in seconds) for periodic Router Advertisement messages. The interval range is from 4 to 1800.

(2 of 2)

- 
- 2 Choose a DNS server, prefix config, and interface.
- 
- 3 Select or enter the DHCP configuration information.
- 
- 4 Enter the maximum and minimum intervals for RA messages.
- 
- 5 Click Save/Apply.
- 
- 6 STOP. This procedure is complete.
-

## Procedure 16 WAN networking configuration

- 1 Select Network > WAN from the top-level menu in the GPON Home Gateway window, as shown in Figure 31.

Figure 31 WAN network window

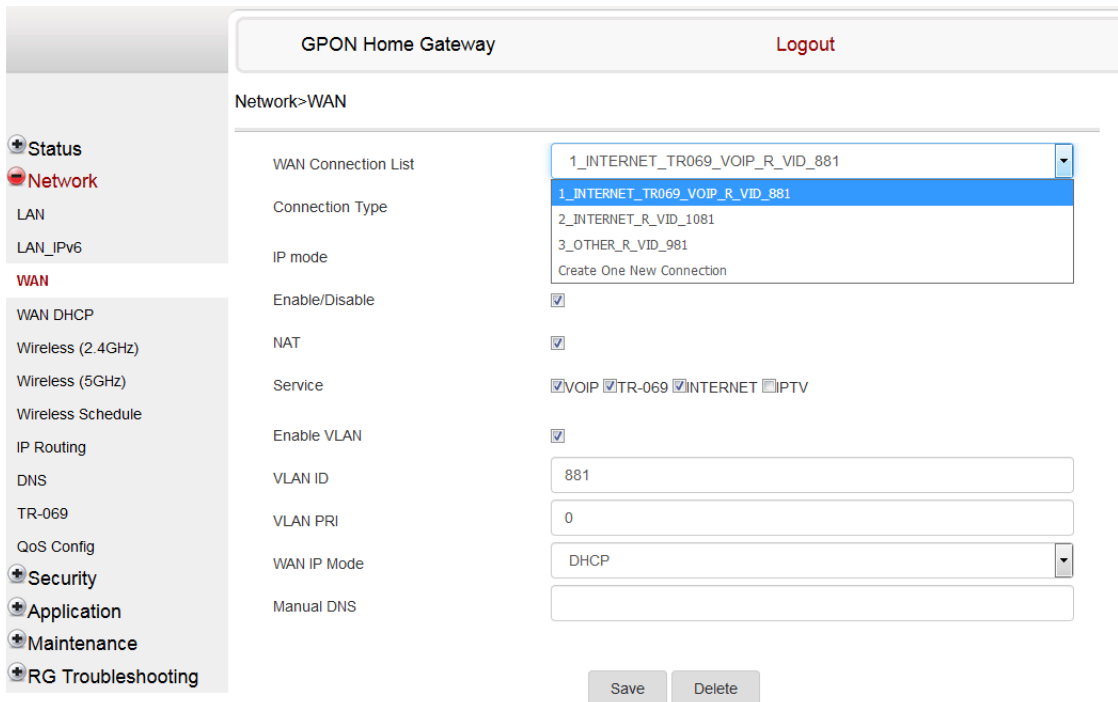

Table 26 describes the fields in the WAN network window.

Table 26 WAN network parameters

Field	Description
WAN Connection List	Choose a WAN connection from the drop-down menu to set the connection parameters
Connection Type	Choose a connection type: IPoE or PPPoE
IP mode	Choose an IP mode from the drop-down menu: IPv4 or IPv6
Enable/Disable	Select this checkbox to enable the WAN connection
NAT	Select this checkbox to enable NAT
Service	Select the checkboxes to enable service types for this connection
Enable VLAN	Select this checkbox to enable VLAN
VLAN ID	Enter the VLAN ID
VLAN PRI	Enter the VLAN PRI

(1 of 2)



Field	Description
WAN IP Mode	Choose an IP mode from the drop-down menu
Manual DNS	Manual Domain Name Server

(2 of 2)

**2** Configure a specific WAN connection.

**3** Click Save.

**4** STOP. This procedure is complete.

### Procedure 17 WAN DHCP configuration

- 1 Select Network > WAN DHCP from the top-level menu in the GPON Home Gateway window, as shown in Figure 32.

**Figure 32 WAN DHCP window**

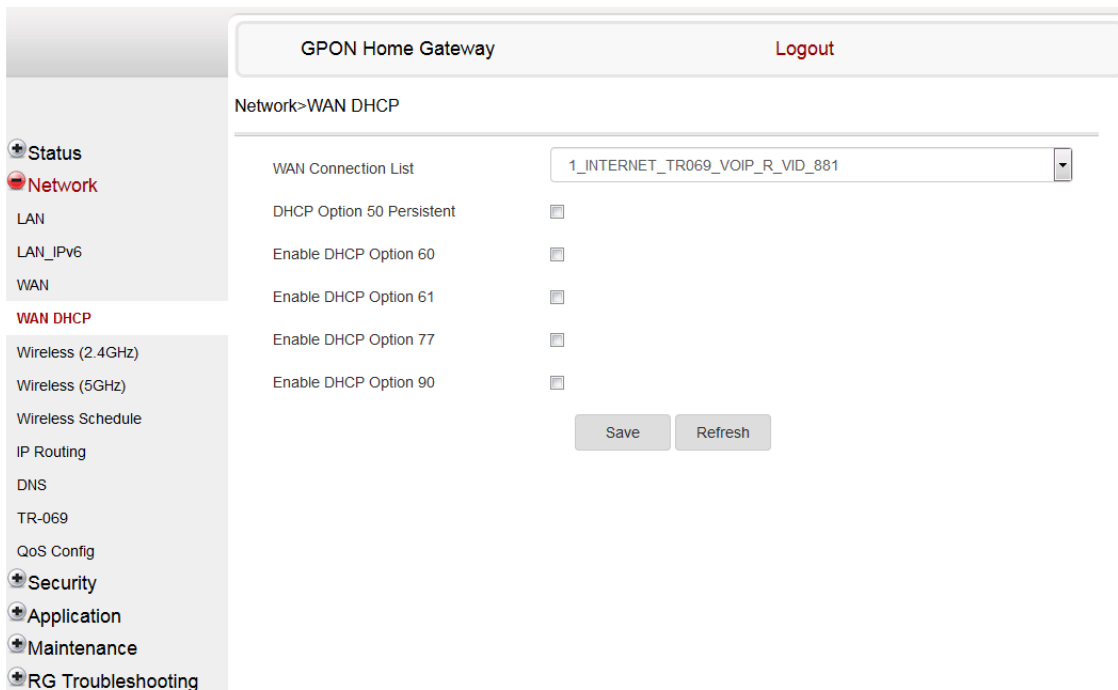

Table 27 describes the fields in the WAN DHCP window.

**Table 27** WAN DHCP parameters

---

Field	Description
WAN Connection List	Choose a WAN connection from the drop-down menu
DHCP Option 50 Persistent	Select this checkbox to enable DHCP Option 50 persistent
Enable DHCP Option 60	Select this checkbox to enable DHCP Option 60 (vendor class identifier)
Enable DHCP Option 61	Select this checkbox to enable DHCP Option 61 (client identifier)
Enable DHCP Option 77	Select this checkbox to enable DHCP Option 77
Enable DHCP Option 90	Select this checkbox to enable DHCP Option 90

---

**2** Configure a WAN DHCP option.

---

**3** Click Save.

---

**4** STOP. This procedure is complete.

---

## Procedure 18 WiFi 2.4GHz networking configuration

- 1 Select Network > WiFi 2.4GHz from the top-level menu in the GPON Home Gateway window, as shown in Figure 33.

Figure 33 WiFi 2.4GHz network window

GPON Home Gateway Logout

Network>Wireless (2.4GHz)

Enable	<input checked="" type="checkbox"/>
Mode	auto(b/g/n)
Bandwidth	20MHz
Channel	Auto
Transmitting Power	100%
WMM	Enable
Total MAX Users	32

### SSID Configuration

SSID Select	SSID1
SSID Name	ALHN-1212
Enable SSID	Enable
SSID Broadcast	Enable
Port Mode	Route
MAX Users	32
Encryption Mode	WPA/WPA2 Personal
WPA Version	WPA/WPA2
WPA Encryption Mode	TKIP/AES
WPA Key	••••••••
	<input type="checkbox"/> Show password
Enable WPS	Disable

Save Refresh

Table 28 describes the fields in the WiFi 2.4GHz network window.

**Table 28** WiFi 2.4GHz network parameters

Field	Description
Enable	Select this checkbox to enable WiFi
Mode	Choose a Wi-Fi mode from the drop-down menu: <ul style="list-style-type: none"> <li>• auto (b/g/n)</li> <li>• b</li> <li>• g</li> <li>• n</li> <li>• b/g</li> <li>• g/n</li> </ul>
Bandwidth	Choose from: <ul style="list-style-type: none"> <li>• 20 MHz</li> <li>• 40 MHz</li> <li>• 20/40 MHz</li> </ul>
Channel	Choose a channel from the drop-down menu or choose Auto to have the channel automatically assigned
Transmitting Power	Choose a percentage for the transmitting power from the drop-down menu: <ul style="list-style-type: none"> <li>• Low (25%)</li> <li>• Medium (50%)</li> <li>• High (75%)</li> <li>• Maximum (100%)</li> </ul>
WMM	Choose Enable or Disable from the drop-down menu to enable or disable WiFi multi-media
Total MAX Users	Enter the number of total MAX users
<b>SSID Configuration</b>	
SSID Select	Choose the SSID from the drop-down menu
SSID Name	Enter the SSID name
Enable SSID	Enable or disable SSID from this drop-down menu
SSID Broadcast	Enable or disable SSID broadcast from this drop-down menu
Port Mode	Select a port mode from the drop-down menu. Route is the default.
MAX Users	Enter the number of MAX users
Encryption Mode	Choose an encryption mode from the drop-down menu: <ul style="list-style-type: none"> <li>• OPEN</li> <li>• WEP</li> <li>• WPA/WPA2 Personal</li> </ul>
WPA Version	Choose a WPA version from the drop-down menu: <ul style="list-style-type: none"> <li>• WPA1</li> <li>• WPA2</li> <li>• WPA1/WPA2</li> </ul>
WPA Encryption Mode	Choose a WPA encryption mode from the drop-down menu: <ul style="list-style-type: none"> <li>• TKIP</li> <li>• AES</li> <li>• TKIP/AES</li> </ul>

(1 of 2)

---

Field	Description
WPA Key	Enter the WPA key
Enable WPS	Choose Enable or Disable WPS from this drop-down menu
WPS Mode	Choose a WPS mode from the drop-down menu: PBC (Push Button Connect) or PIN (Personal Identification Number)

**(2 of 2)**

- 
- 2** Configure the WiFi connection.

---

  - 3** If you have enabled and configured WPS, click WPS connect.

---

  - 4** Click Save.

---

  - 5** STOP. This procedure is complete.
-

## Procedure 19 WiFi 5GHz networking configuration

- 1 Select Network > WiFi 5GHz from the top-level menu in the GPON Home Gateway window, as shown in Figure 34.

**Figure 34** WiFi 5GHz network window

The screenshot shows the 'GPON Home Gateway' interface with a 'Logout' button. The main menu on the left includes Status, Network (selected), LAN, LAN\_IPv6, WAN, WAN DHCP, Wireless (2.4GHz), **Wireless (5GHz)**, Wireless Schedule, IP Routing, DNS, TR-069, QoS Config, Security, Application, Maintenance, and RG Troubleshooting. The 'Network-Wireless (5GHz)' configuration page is displayed with the following settings:

- Enable:
- Bandwidth: 80MHz
- Channel: Auto
- Transmitting Power: 100%
- WMM: Enable
- Total MAX Users: 32

**SSID Configuration**

- SSID Select: SSID5
- SSID Name: ALHN-1212-5
- Enable SSID: Enable
- SSID Broadcast: Enable
- Port Mode: Route
- MAX Users: 32
- Encryption Mode: WPA2-AES
- WPA Key: [Masked]
- Show password:
- Enable WPS: Disable

Buttons: Save, Refresh

Table 29 describes the fields in the WiFi 5GHz network window.

**Table 29** WiFi 5GHz network parameters

Field	Description
Enable	Select this checkbox to enable WiFi
Bandwidth	Choose from: <ul style="list-style-type: none"> <li>• 20 MHz</li> <li>• 40 MHz</li> <li>• 80 MHz</li> </ul>

(1 of 2)

Field	Description
Channel	Choose a channel from the drop-down menu or choose Auto to have the channel automatically assigned
Transmitting Power	Choose a percentage for the transmitting power from the drop-down menu: <ul style="list-style-type: none"> <li>• Low (20%)</li> <li>• Medium (40%)</li> <li>• High (60%)</li> <li>• Maximum (100%)</li> </ul>
WMM	Choose Enable or Disable from the drop-down menu to enable or disable WiFi multi-media
Total MAX Users	Enter the total number of MAX users
<b>SSID Configuration</b>	
SSID Select	Choose the SSID from the drop-down menu
SSID Name	Change the name of the selected SSID
Enable SSID	Choose Enable or disable SSID from this drop-down menu
SSID Broadcast	Choose Enable or disable SSID broadcast from this drop-down menu
Port Mode	Select a port mode from the drop-down menu. Route is the default.
MAX Users	Enter the number of MAX users
Encryption Mode	Choose an encryption mode from the drop-down menu: <ul style="list-style-type: none"> <li>• OPEN</li> <li>• WEP</li> <li>• WPA/WPA2 Personal</li> </ul>
WPA Key	Enter the WPA key
Enable WPS	Choose Enable or Disable WPS from this drop-down menu
WPS Mode	Choose a WPS mode from the drop-down menu: PBC (Push Button Connect) or PIN (Personal Identification Number)

**(2 of 2)**

- 
- 2** Configure the WiFi connection.

---

  - 3** If you have enabled and configured WPS, click WPS connect.

---

  - 4** Click Save.

---

  - 5** STOP. This procedure is complete.

---

## Procedure 20 Wireless scheduling

- 1 Select Network > Wireless Schedule from the top-level menu in the GPON Gateway window, as shown in Figure 35.

**Figure 35 Wireless Schedule window**

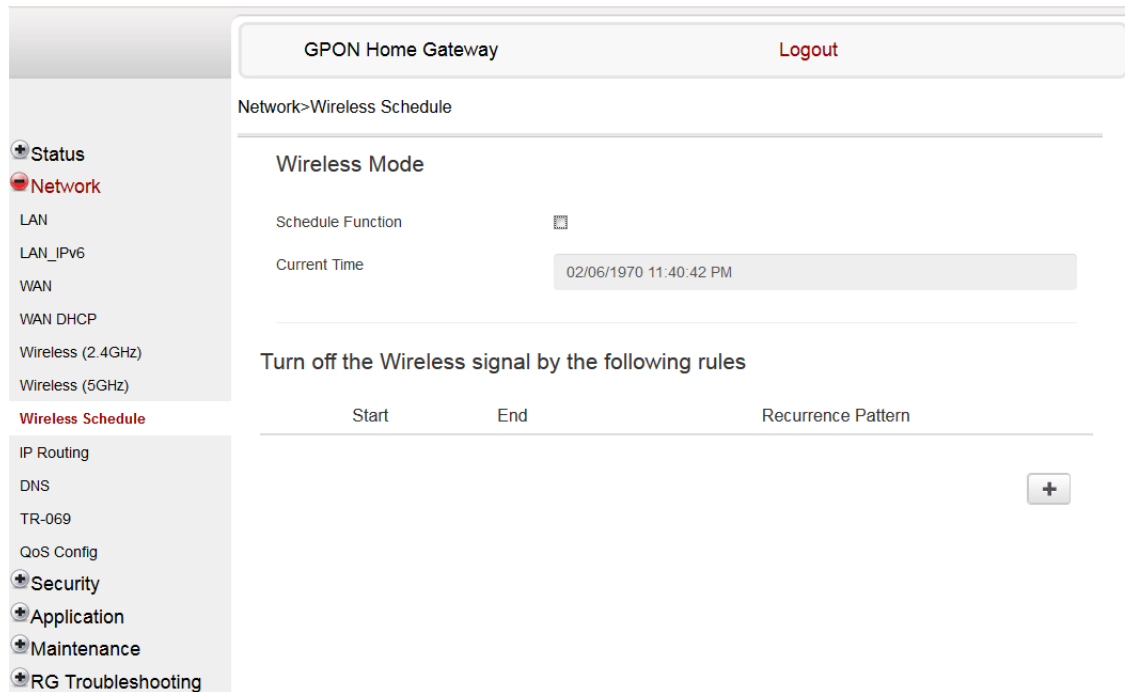

- 2 Select the Schedule Function checkbox to turn the wireless signal off for the configured period.
- 3 Click the plus sign (+) to add a scheduling rule.  
A separate panel displays for configuring wireless schedule rules.
- 4 Enter a start time and end time for the period in which you want the wireless signal off.
- 5 Choose Everyday or Individual Days from the drop-down menu.
- 6 If you chose Individual Days, select the checkboxes for the desired days.  
The Recurrence Pattern shows the rules created to date.
- 7 If desired, click the plus sign (+) to add more rules.



- 8 Click Save Changes.
- 9 STOP. This procedure is complete.

### Procedure 21 IP Routing configuration

- 1 Select Network > IP Routing from the top-level menu in the GPON Home Gateway window, as shown in Figure 36.

**Figure 36 IP Routing network window**

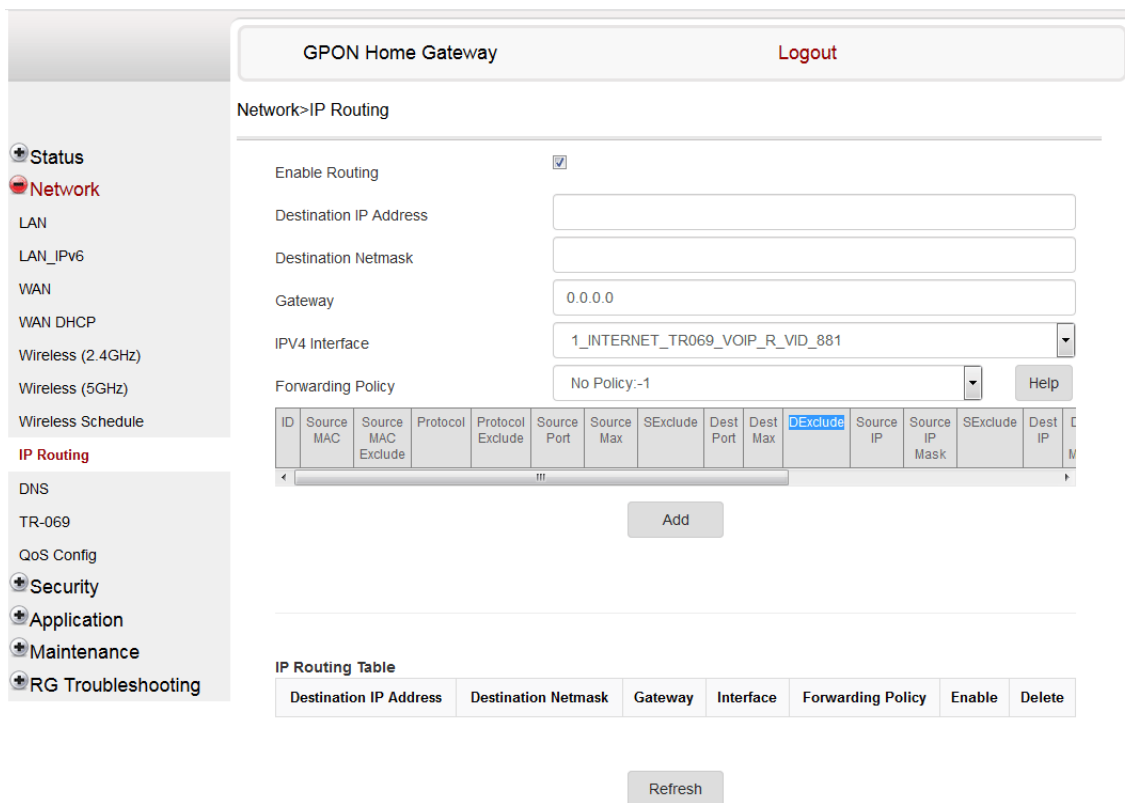

Table 30 describes the fields in the IP Routing network window.

**Table 30 IP Routing network parameters**

Field	Description
Enable Routing	Select this checkbox to enable routing

(1 of 2)

---

Field	Description
Destination IP Address	Enter the destination IP address
Destination Netmask	Enter the destination network mask
Gateway	Enter the gateway address
IPv4 Interface	Choose a WAN connection previously created in the WAN network window from the drop-down menu
Forwarding Policy	Choose a forwarding policy from the drop-down menu

(2 of 2)

---

**2** Enter the IP routing information.

---

**3** Click Add.

---

**4** STOP. This procedure is complete.

---

## Procedure 22 DNS configuration

- 1 Select Network > DNS from the top-level menu in the GPON Home Gateway window, as shown in Figure 37.

**Figure 37** DNS network window

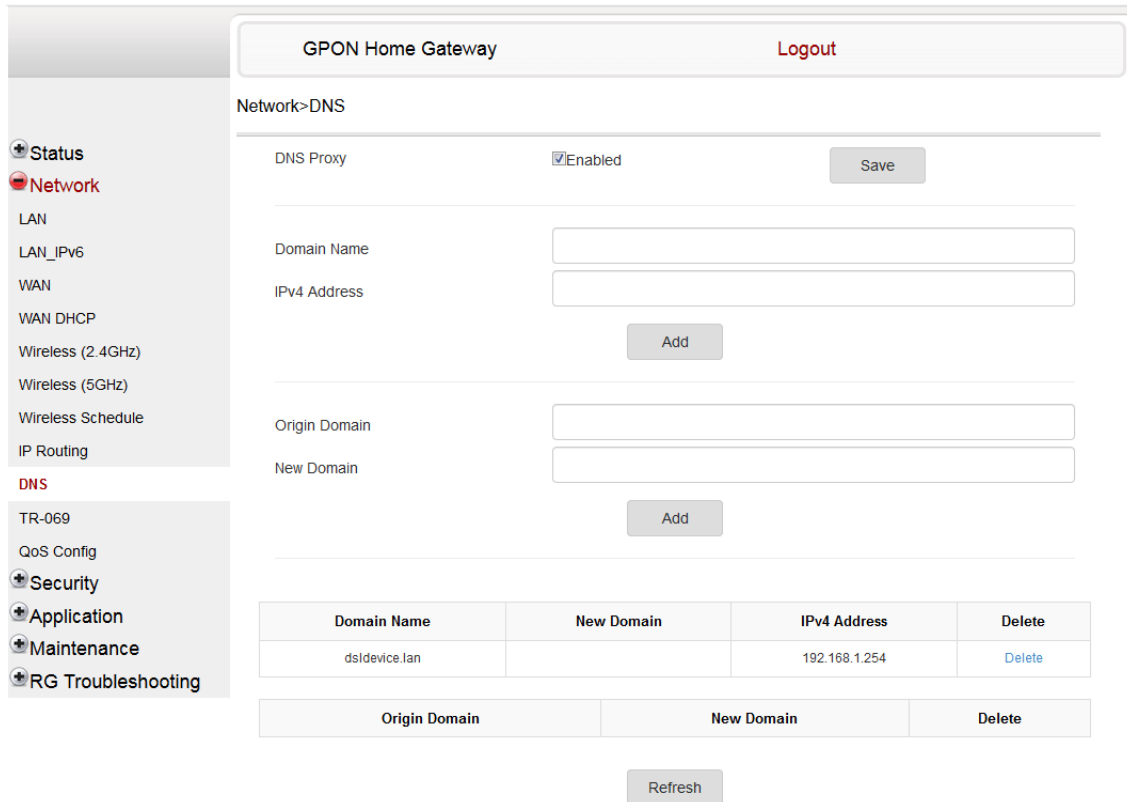

Table 31 describes the fields in the DNS network window.

**Table 31** DNS network parameters

Field	Description
DNS Proxy	Select the Enabled checkbox to enable DNS proxy
Domain Name	Domain name
IPv4 Address	Domain IP address
Origin Domain	Origin domain name
New Domain	New domain name

- 2 Select the Enabled checkbox and click Save to enable DNS proxy.

- 3 Enter the domain name and IPv4 address and click Add.
- 4 If required, associate an origin domain with a new domain, click Add.
- 5 STOP. This procedure is complete.

### Procedure 23 TR-069 configuration

- 1 Select Network > TR-069 from the top-level menu in the GPON Home Gateway window, as shown in Figure 38.

**Figure 38 TR-069 network window**

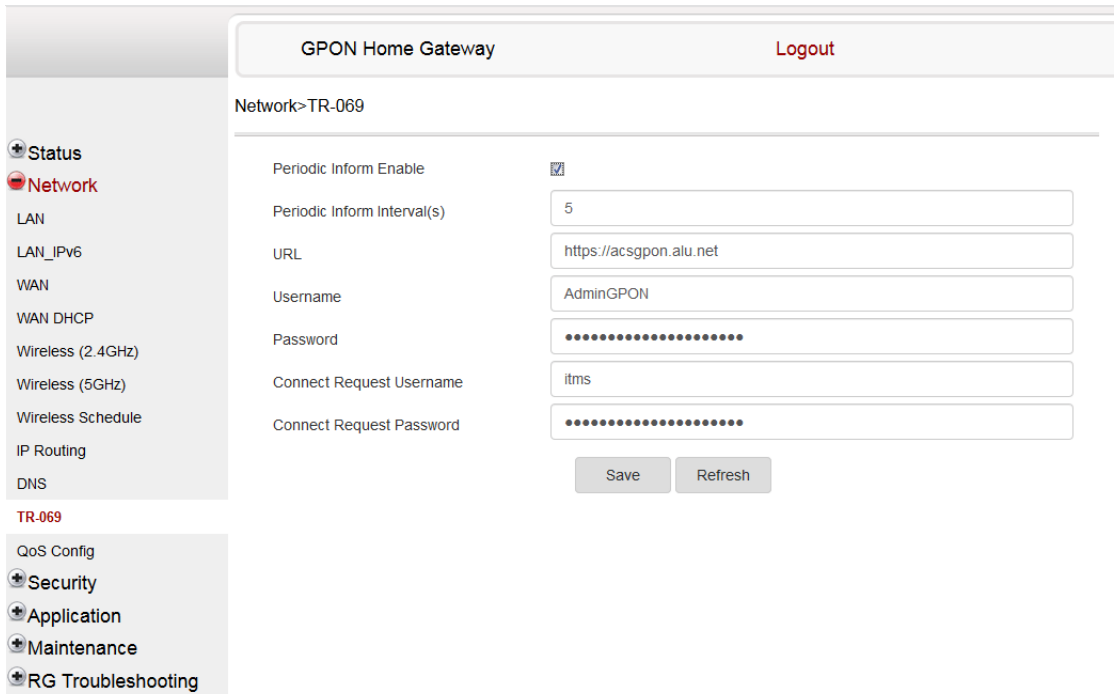

Table 32 describes the fields in the TR-069 network window.

**Table 32 TR-069 network parameters**

Field	Description
Periodic Inform Enable	Select this checkbox to enable periodic inform updates
Periodic Inform Interval(s)	Time between periodic inform updates, in seconds

(1 of 2)

---

Field	Description
URL	URL of the auto-configuration server
Username	Username used to log in to the auto-configuration server
Password	Password used to log in to the auto-configuration server
Connect Request Username	Username used to log in to the ONT
Connect Request Password	Password used to log in to the ONT

(2 of 2)

---

**2** Configure TR-069 by entering the required information.

---

**3** Click Save.

---

**4** STOP. This procedure is complete.

---

## Procedure 24 QoS configuration

---

**1** Select Network > QoS Config from the top-level menu in the Home Gateway window.

Figure 39 shows the window for configuring QoS L2 (Layer 2 packet sizes).

Figure 39 QoS Config window (L2)

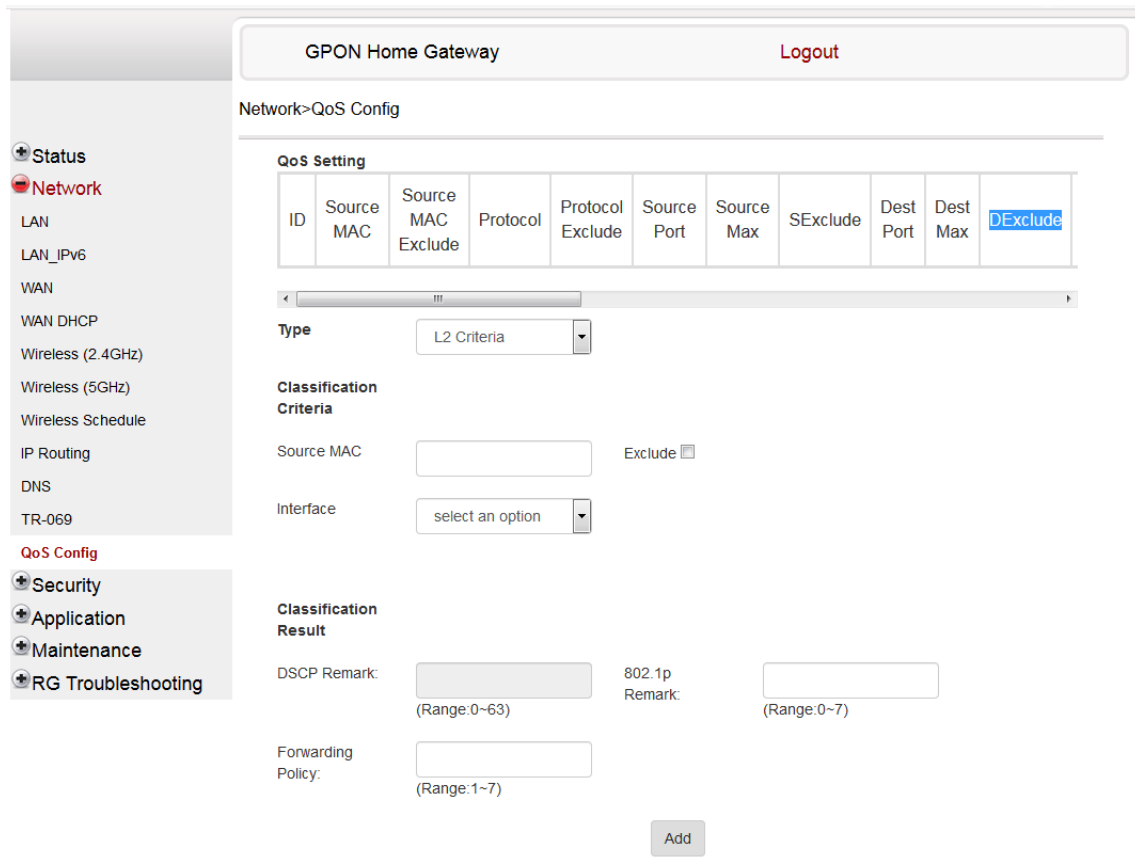

Figure 40 shows the window for configuring QoS L3 (Layer 3 packet sizes).

**Figure 40 QoS Config window (L3)**

Table 33 describes the fields in the QoS Config window.

**Table 33 QoS Config parameters**

Field	Description
<b>QoS Setting</b>	

(1 of 2)

Field	Description
Type	Choose a QoS service layer type from the drop-down menu L2 or L3.
<b>Classification Criteria</b>	
Source MAC	Enter the source MAC Select the Exclude checkbox to exclude the source MAC
Interface	Choose an interface from the drop-down menu
<b>Classification Result</b>	
DSCP Remark	Enter the value for the DSCP mark (range: 0-63); valid only for L3 Criteria
802.1p Remark	Enter the value for the 802.1p (range: 0-7)
Forwarding Policy	Enter the number for the forwarding policy (range: 1-7)
<b>Additional fields for L3</b>	
Protocol	Choose a protocol from the drop-down menu, or select the Exclude checkbox
Application	Choose an application from the drop-down menu
Source IP and Source IP Mask	Enter the values for the source IP and IP mask, or select the Exclude checkbox
Destination IP and Destination IP Mask	Enter the values for the destination IP and IP mask, or select the Exclude checkbox
Source Port and Source Port Max	Enter the values for the source port and port max (highest port number) or select the Exclude checkbox
Destination Port and Destination Port Max	Enter the values for the destination port and port max (highest port number), or select the Exclude checkbox

(2 of 2)

---

**2** Choose a QoS type from the drop-down menu: L2 or L3.

---

**3** Configure a QoS policy.

---

**4** Click Add to add a QoS policy.

---

**5** STOP. This procedure is complete.

---

## 8.2.4 Security configuration

The G-2425G-A ONT supports security configuration, including:

- firewall
- MAC filter
- IP filter
- URL filter



- parental control
- DMZ and ALG
- access control

**Procedure 25 Firewall configuration**

- 1 Select Security > Firewall from the top-level menu in the GPON Home Gateway window, as shown in Figure 41.

**Figure 41 Firewall window**

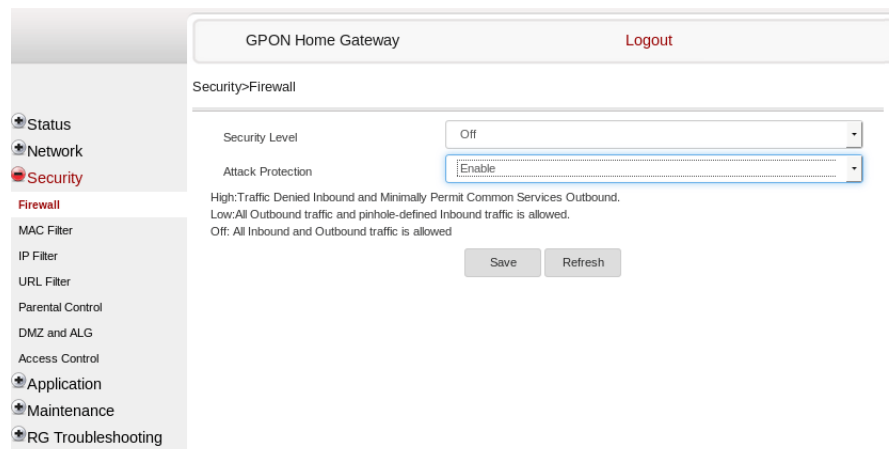

Three security levels are available: High, Low, and Off.

High—Traffic denied inbound and minimally permit common services outbound

Low—All outbound traffic and pinhole-defined inbound traffic is allowed

Off—All inbound and outbound traffic is allowed

Table 34 describes the fields in the firewall window.

**Table 34 Firewall parameters**

Field	Description
Security level	Choose the security level from the drop-down menu: High, Low, or Off
Attack Protect (Protection against DoS or DDoS attacks)	Choose enable or disable attack protect from the drop-down menu The default is Enable

- 2 Configure the firewall.

- 3 Click Save.
- 4 STOP. This procedure is complete.

### Procedure 26 MAC filter configuration

- 1 Select Security > Mac Filter from the top-level menu in the GPON Home Gateway window, as shown in Figure 42.

Figure 42 MAC filter window

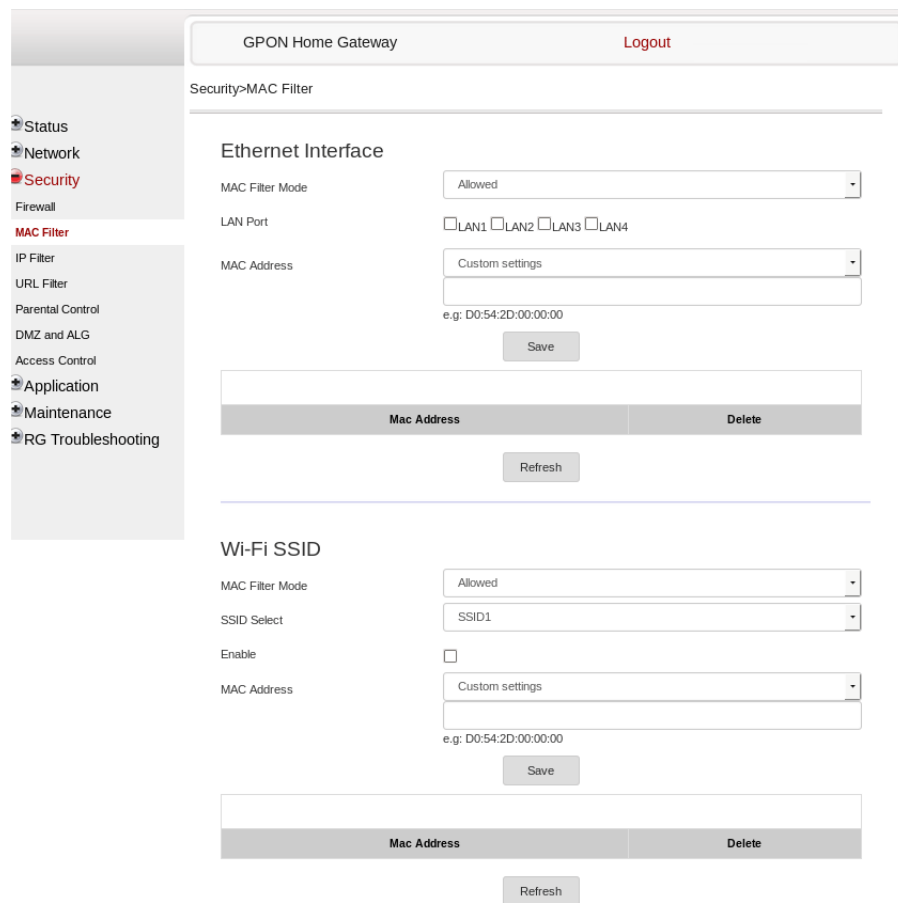

Table 35 describes the fields in the MAC filter window.

**Table 35** MAC filter parameters

Field	Description
<b>Ethernet Interface</b>	
MAC Filter Mode	Choose the MAC filter mode from the drop-down menu: Blocked or Allowed
LAN Port	LAN port range
MAC Address	Choose the MAC address from the drop-down menu or enter the address in the text field
<b>Wi-Fi SSID</b>	
MAC Filter Mode	Choose the MAC filter mode from the drop-down menu: Blocked or Allowed
SSID Select	Choose the SSID from the drop-down menu
Enable	Select this checkbox to enable the MAC filter
MAC Address	Choose a MAC address from the drop-down menu or enter the address in the text field

---

**2** Click Refresh to update the information.

---

**3** Configure a MAC filter.

---

**4** Click Add.

---

**5** STOP. This procedure is complete.

---

## Procedure 27 IP filter configuration

- 1 Select Security > IP filter from the top-level menu in the GPON Home Gateway window, as shown in Figure 43.

**Figure 43 IP filter window**

Table 36 describes the fields in the IP filter window.

**Table 36 IP filter parameters**

Field	Description
Enable IP Filter	Select this checkbox to enable an IP filter
Mode	Choose an IP filter mode from the drop-down menu: <ul style="list-style-type: none"> <li>• Drop for upstream</li> <li>• Drop for downstream</li> </ul>
Internal Client	Choose an internal client from the drop-down menu: <ul style="list-style-type: none"> <li>• Customer setting - uses the IP address input below</li> <li>• IP - uses the connecting devices' IP to the ONT</li> </ul>
Local IP Address	Local IP address
Source Subnet Mask	Source subnet mask
Remote IP Address	Remote IP address
Destination Subnet Mask	Destination subnet mask
Protocol	Choose an application protocol or all from the drop-down menu

- 2 Configure the IP filter.

- 3 Click Add.
- 4 STOP. This procedure is complete.

### Procedure 28 URL filter configuration

- 1 Select Security > URL Filter from the top-level menu in the GPON Home Gateway window, as shown in Figure 44.

**Figure 44 URL Filter window**

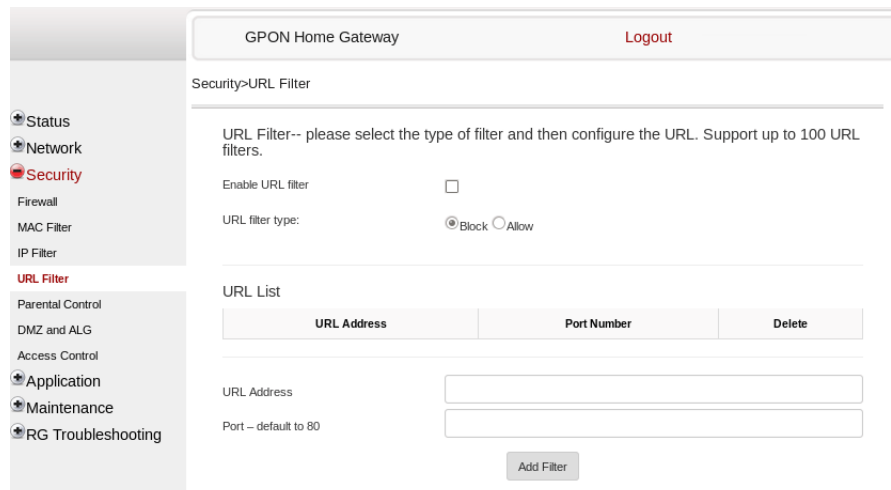

**Note** — You cannot use URL filtering for HTTPS. The URL is encrypted when using HTTPS.

Table 37 describes the fields in the URL Filter window.

**Table 37 URL Filter parameters**

Field	Description
Enable URL filter	Select the checkbox to enable the URL filter
URL filter type	Select the radio button to block the URL or allow the URL
<b>URL List</b>	

(1 of 2)

Field	Description
URL Address	Type the URL address
Port - default to 80	Type the port number; the default is 80

(2 of 2)

- 
- 2 Configure the URL Filter.
- 
- 3 Click Add Filter.
- 
- 4 STOP. This procedure is complete.
-

**Procedure 29 Parental control**

---

- 1 Select Security > Parent Control from the top-level menu in the GPON Gateway window, as shown in Figure 45.

**Figure 45 Parental Control window**

GPON Home Gateway
Logout

- Status
- Network
- Security
- Firewall
- MAC Filter
- IP Filter
- URL Filter
- Parental Control
- DMZ and ALG
- Access Control
- Application
- Maintenance
- RG Troubleshooting

Security>Parental Control

Block access of LAN devices at given times, according to their MAC, IPv4 or URL addresses

Access Control

Policy Name	Device	IP	URL	Days Of Week	From	To	Delete	Edit	Enable
Add Access Control rule									

**Policy Name:**

New Policy
▼

**MAC Address:**

New MAC
▼

e.g: D0:54:2D:00:00:00

**IPv4 Address:**

New IP
▼

e.g: 192.168.1.100

**Url Port:**

e.g: http://www.baidu.com

e.g: 0~65535 (default: 80)

**Days of Week:**

Everyday
▼

**From:**

e.g: 00:00~23:59

**To:**

e.g: 00:00~23:59

Table 38 describes the fields in the Parental Control window.



**Table 38** Parental control parameters

Field	Description
Access Control	Select this checkbox to enable access control
<b>Add Access Control rule</b>	
Policy Name	Enter a name for the parental control policy or choose a policy from the list
MAC Address	Enter the MAC address or choose a MAC address from the list
IPv4 Address	Enter the IPv4 address for the device or choose an IPv4 address from the list
Url Port	Enter the URL port for the device
Days of week	Choose Every Day, or Individual Days and select the checkboxes for the days of the week for which the policy applies
From	Enter the times for the policy to be in effect
To	

---

**2** Select the Access Control checkbox.

---

**3** Click the plus sign (+) to add a policy.

A separate panel displays for configuring the policy name, IP address of the device, and dates and times for the policy.

---

**4** Configure the parental control policy.

---

**5** Click Enable to activate the policy.

---

**6** STOP. This procedure is complete.

---

## Procedure 30 DMZ and ALG configuration

- 1 Select Security > DMZ and ALG from the top-level menu in the GPON Home Gateway window, as shown in Figure 46.

**Figure 46 DMZ and ALG window**

Table 39 describes the fields in the DMZ and ALG window.

**Table 39 DMZ and ALG parameters**

Field	Description
ALG Config	Select the checkboxes to enable the protocols to be supported by the ALG: FTP, TFTP, SIP, H323, RTSP, L2TP, IPSEC, PPTP
<b>DMZ Config</b>	
WAN Connection List	Choose a WAN connection from the drop-down menu
Enable DMZ	Select this checkbox to enable DMZ on the chosen WAN connection
DMZ IP Address	Choose Customer Setting and enter the DMZ IP address or choose the IP address of a connected device from the drop-down menu

- 2 Configure ALG.

- 3 Click Save ALG.

- 4 Configure DMZ.

5 Click Save DMZ.

6 STOP. This procedure is complete.

### Procedure 31 Access control configuration

This procedure describes how to configure the access control level (ACL).



**Note 1** — ACL takes precedence over the firewall policy.

**Note 2** — The trusted network object will be shared for all WAN connections; it is not applied individually to a WAN connection.

- 1 Select Security > Access Control from the top-level menu in the GPON Home Gateway window, as shown in Figure 47.

**Figure 47 Access Control window**

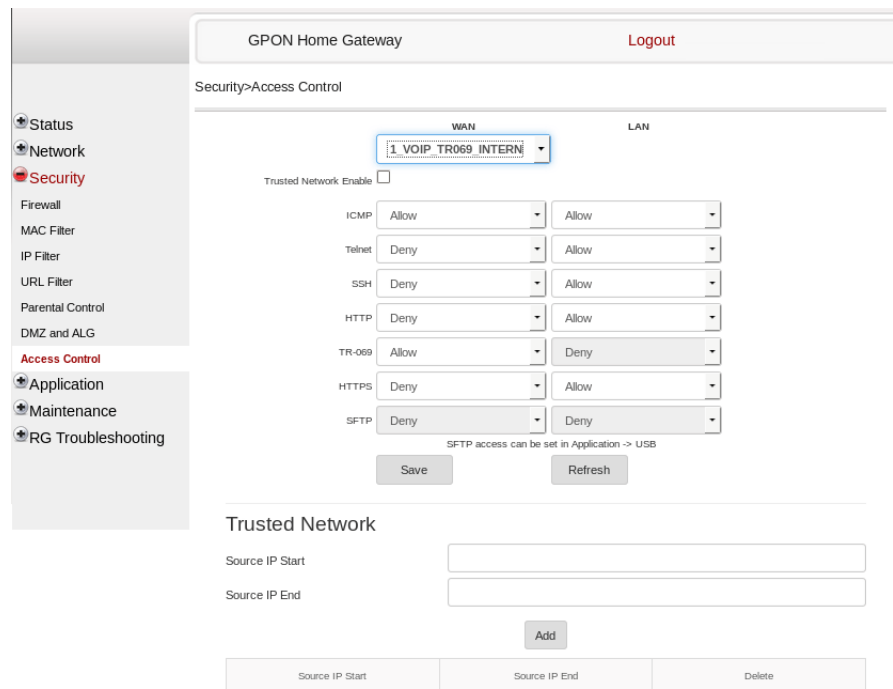

Table 40 describes the fields in the Access Control window.

**Table 40 Access control parameters**

Field	Description
WAN	Choose a connection from the drop-down menu
Trusted Network Enable	Click to enable or disable
ICMP, Telnet, SSH, HTTP, TR-069, HTTPS, SFTP	Select an access control level for each protocol: WAN side: Allow, Deny, or Trusted Network Only LAN side: Allow or Deny
<b>Trusted Network</b>	
Source IP Start	Enter a start IP address for the new subnet trusted network
Source IP End	Enter an end IP address for the new subnet trusted network

---

**2** Select a WAN connection from the drop-down menu.

---

**3** Click to enable or disable Trusted Network.

---

**4** Select an access control level for each of the protocols: ICMP, Telnet, SSH, HTTP, TR-069, HTTPS, and SFTP for both the WAN side and the LAN side.

---

**5** Click Save.

---

**6** Optionally, add one or more subnet trusted networks.

The maximum number of entries is 32.

You can also use the Source IP fields to delete a previously created entry for a subnet trusted network.

---

**7** STOP. This procedure is complete.

---

## 8.2.5 Application configuration

The G-2425G-A ONT supports application configuration, including:

- port forwarding
- port triggering
- DDNS
- NTP

- USB
- UPnP and DLNA

### Procedure 32 Port forwarding configuration

- 1 Select Application > Port forwarding from the top-level menu in the GPON Home Gateway window, as shown in Figure 48.

**Figure 48** Port forwarding window

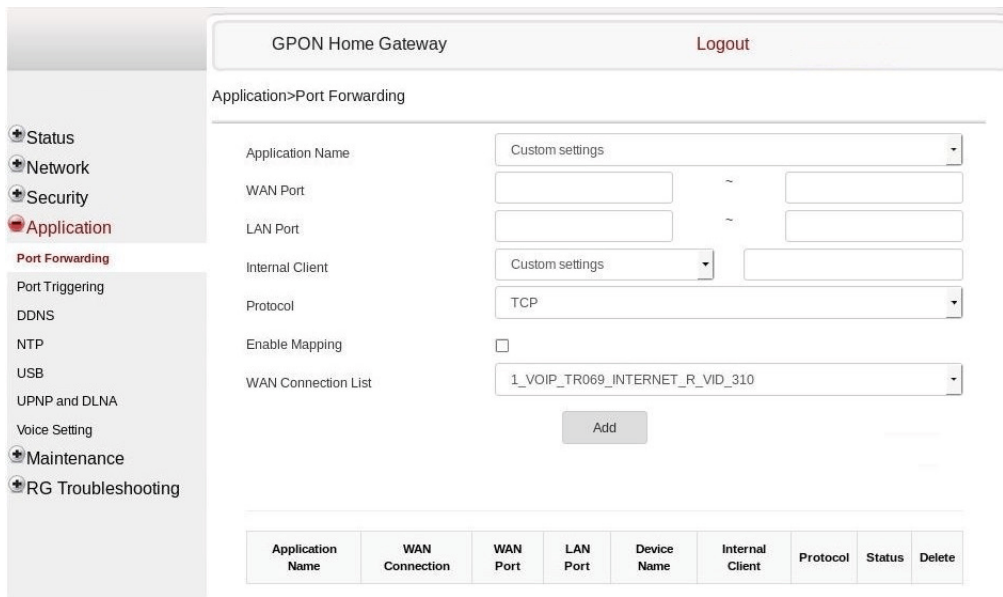

Table 41 describes the fields in the port forwarding window.

**Table 41** Port forwarding parameters

Field	Description
Application Name	Choose an application name from the drop-down menu The default is Custom settings
WAN Port	WAN port range
LAN Port	LAN port range
Internal Client	Choose a connected device from the drop-down menu and enter the associated IP address
Protocol	Choose the port forwarding protocol from the drop-down menu: <ul style="list-style-type: none"> <li>• TCP</li> <li>• UDP</li> <li>• TCP/UDP</li> </ul>
Enable Mapping	Select this checkbox to enable mapping

(1 of 2)

Field	Description
WAN Connection List	Choose a WAN connection from the drop-down menu Note: only active devices are shown on this menu

(2 of 2)

- 2 Configure port forwarding.
- 3 Click Add.
- 4 STOP. This procedure is complete.

### Procedure 33 Port triggering

- 1 Select Application > Port Triggering from the top-level menu in the GPON Gateway window, as shown in Figure 49.

Figure 49 Port Triggering window

Table 42 describes the fields in the Port Triggering window.

**Table 42** Port triggering parameters

Field	Description
Application Name	Choose an application name from the drop-down menu The default is Custom settings
Open Port	Enter the open port range
Triggering Port	Enter the triggering port range
Expire Time	Enter the expiration time in seconds
Open Protocol	Choose the open port protocol from the drop-down menu: <ul style="list-style-type: none"><li>• TCP</li><li>• UDP</li><li>• TCP/UDP</li></ul>
Trigger Protocol	Choose the triggering port protocol from the drop-down menu: <ul style="list-style-type: none"><li>• TCP</li><li>• UDP</li><li>• TCP/UDP</li></ul>
Enable Triggering	Select this checkbox to enable port triggering
WAN Connection List	Choose a WAN connection from the drop-down menu Note: only active devices are shown on this menu

- 
- 2 Configure port triggering.
- 
- 3 Click Add.
- 
- 4 STOP. This procedure is complete.
-

## Procedure 34 DDNS configuration

- 1 Select Application > DDNS from the top-level menu in the GPON Home Gateway window, as shown in Figure 50.

**Figure 50 DDNS window**

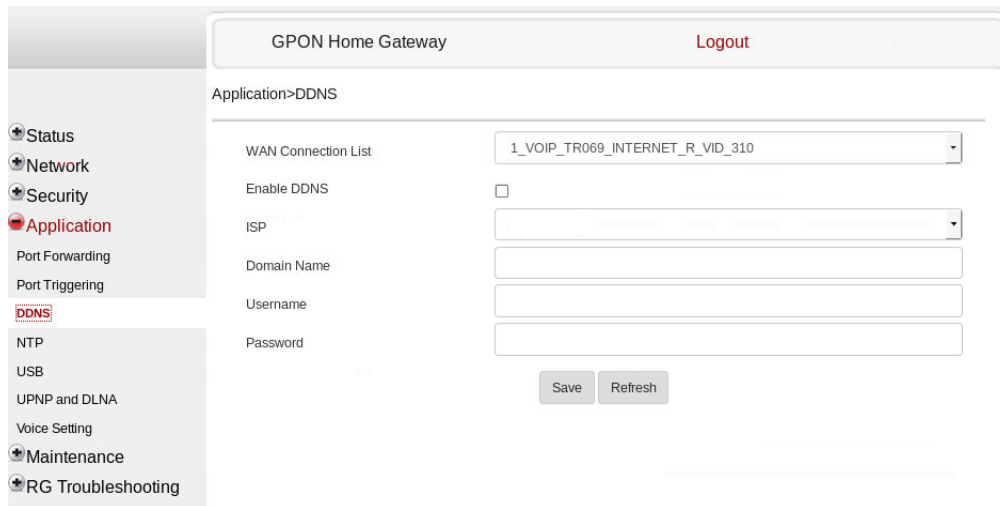

Table 43 describes the fields in the DDNS window.

**Table 43 DDNS parameters**

Field	Description
WAN Connection List	Choose a WAN connection from the drop-down menu
Enable DDNS	Select this checkbox to enable DDNS on the chosen WAN connection
ISP	Choose an ISP from the drop-down menu.
Domain Name	Domain name
Username	Username
Password	Password
DDNS Status	Displays the status of the DDNS: Synchronized, Synchronization failed, or blank if no update message has been received from the ISP.

- 2 Configure DDNS.
- 3 Click Save.
- 4 STOP. This procedure is complete.



## Procedure 35 NTP configuration

- 1 Select Application > NTP from the top-level menu in the GPON Home Gateway window, as shown in Figure 51.

**Figure 51** NTP window

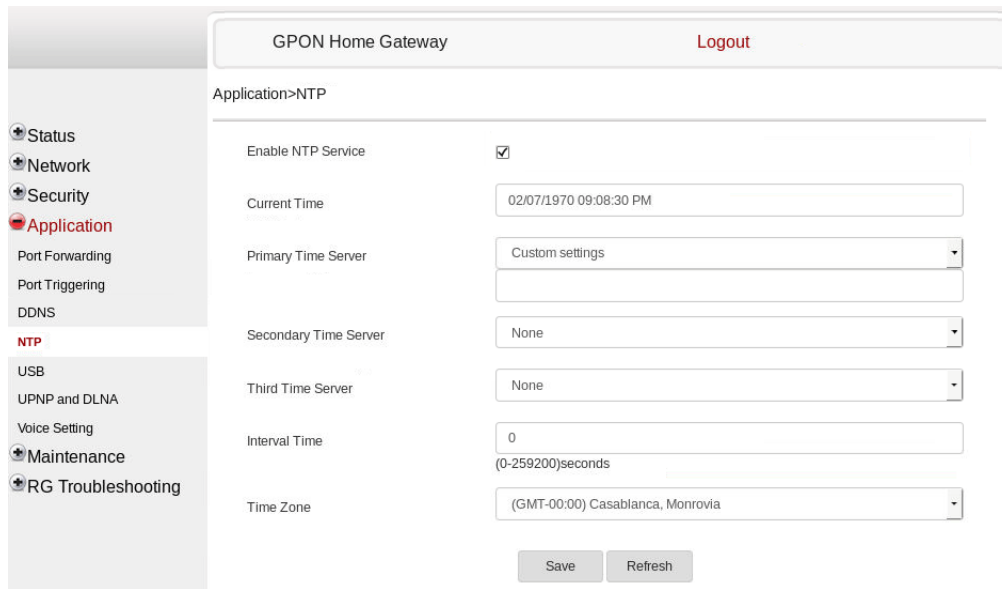

Table 44 describes the fields in the NTP window.

**Table 44** NTP parameters

Field	Description
Enable NTP Service	Select this checkbox to enable the NTP service
Current Time	Enter the current local date and time
Primary Time Server	Choose a time server from the drop-down menu or choose Customer setting and enter the address of the time server.
Secondary Time Server	Choose a time server from the drop-down menu or choose Customer setting and enter the address of the time server.
Third Time Server	Choose a time server from the drop-down menu or choose Customer setting and enter the address of the time server.
Interval Time	Interval at which to get the time from the time server, in seconds
Time Zone	Choose the local time zone from the drop-down menu

- 2 Configure the NTP.

3 Click Save.

4 STOP. This procedure is complete.

### Procedure 36 USB configuration

You can connect USB storage devices and USB printers to the USB ports of the device. The USB menu enables you to configure FTP and SFTP for your USB storage devices.

The USB connected devices are shown in overview table on the bottom of the USB window.

1 Select Application > USB from the top-level menu, as shown in Figure 52.

**Figure 52** USB window

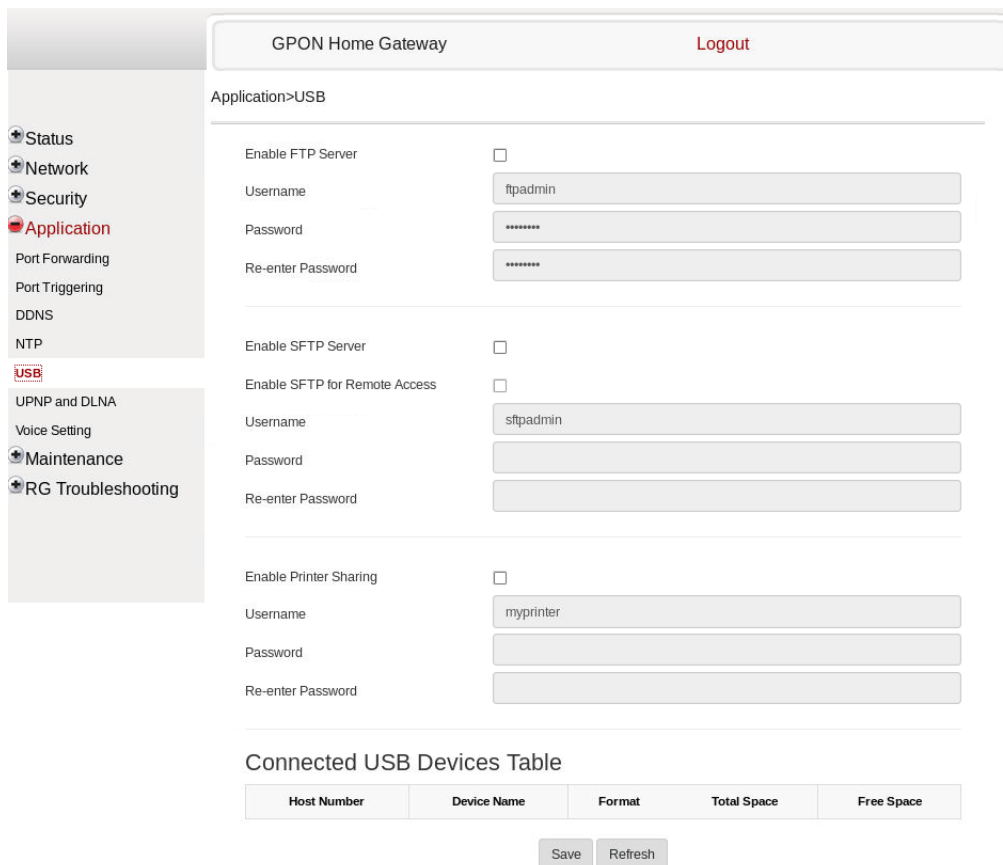

Table 45 describes the fields in the USB window.

**Table 45** USB parameters

Field	Description
Enable FTP server	Select this checkbox to enable using an FTP server
Username	Username for the FTP server
Password	Password for the FTP server
Re-enter Password	Password for the FTP server
Enable SFTP server	Select this checkbox to enable using an SFTP server
Enable SFTP for Remote Access	Select this checkbox to enable SFTP for remote access
Username	Username for the SFTP server
Password	Password for the SFTP server
Re-enter Password	Password for the SFTP server
Enable Printer Sharing	Select this checkbox to enable printer sharing Printer sharing is disabled by default
Username	Username for the SFTP server
Password	Password for the SFTP server
Re-enter Password	Password for the SFTP server
Connected USB Devices Table	For each printer that is connected to the ONT, the following fields are displayed: <ul style="list-style-type: none"> <li>• Host Number for example: Printer1, Printer2</li> <li>• Device Name: name or identification for the USB device</li> <li>• Format: displays the storage format (applies only to a USB storage device)</li> <li>• Total space (applies only to a USB storage device)</li> <li>• Free space (applies only to a USB storage device)</li> </ul>

---

**2** Configure USB.

---

**3** Click Save.

---

**4** STOP. This procedure is complete.

---

---

## Procedure 37 UPNP and DLNA configuration

---

- 1 Select Application > UPNP and DLNA from the top-level menu in the GPON Home Gateway window, as shown in Figure 53.

**Figure 53 UPNP and DLNA window**

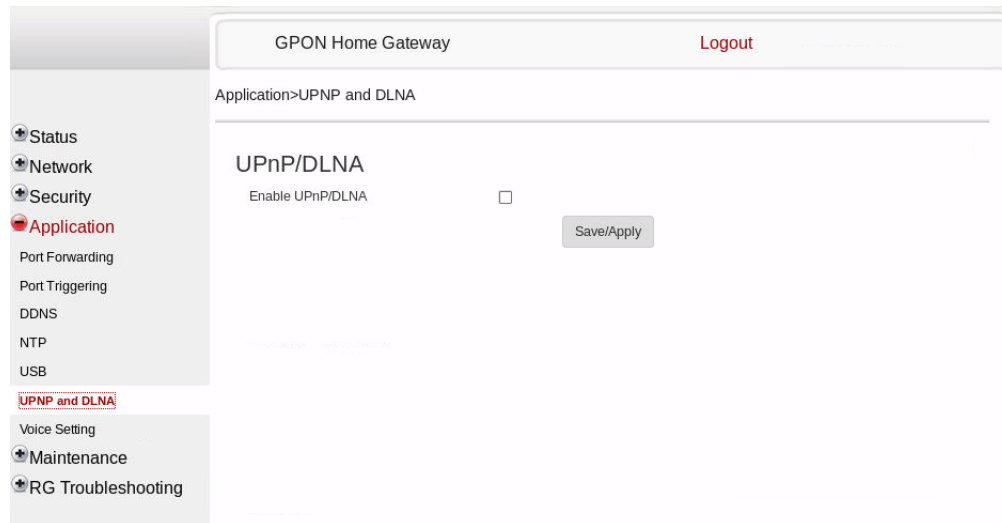

- 2 Select the Enable UPnP/DLNA checkbox to enable UPnP/DLNA.
  - 3 Click Save/Apply.
  - 4 STOP. This procedure is complete.
- 

## 8.2.6 Maintenance

The G-2425G-A ONT supports maintenance tasks, including:

- change password
- test WAN speed
- configure LOID
- configure SLID
- manage device
- backup and restore
- upgrade firmware
- reboot device
- restore factory defaults

- diagnose WAN connections
- view log

### **Procedure 38 Password configuration**

A password must adhere to the password rules, which are as follows:

- the password may consist of uppercase letters, lowercase letters, digital numbers, and the following special characters ! # + , - / @ \_ : = ]
- the password length must be from 8 to 24 characters
- the first character must be a digital number or a letter
- the password must contain at least two types of characters: numbers, letters, or special characters
- the same character must not appear more than 8 times in a row

When the password meets the password rules, the application displays the message “Your password has been changed successfully”.

When the password does not meet the password rules, the application displays a message to indicate which password rule has not been followed, for example:

- the password is too short
- the password is too long

- the first character cannot be a special character
- there are not enough character classes

- 1 Select Maintain > Password from the top-level menu in the GPON Home Gateway window, as shown in Figure 54.

**Figure 54 Password window**

The screenshot shows the 'GPON Home Gateway' interface. At the top right, there is a 'Logout' button. The breadcrumb navigation is 'Maintenance>Password'. On the left, a sidebar menu includes 'Status', 'Network', 'Security', 'Application', 'Maintenance' (selected), and 'RG Troubleshooting'. Under 'Maintenance', 'Password' is highlighted. The main content area has four input fields: 'Original Password', 'New Password', 'Re-enter Password', and 'Prompt Message'. At the bottom of the form are 'Save' and 'Refresh' buttons.

Table 46 describes the fields in the password window.

**Table 46 Password parameters**

Field	Description
Original Password	Current password
New Password	New password
Re-enter password	Password must match the new password entered above
Prompt message	Password prompt message

- 2 Configure the new password.

- 
- 3 Click Save.
- 
- 4 STOP. This procedure is complete.
- 

### Procedure 39 WAN speed test

- 
- 1 Select Maintain > Speed Test from the top-level menu in the GPON Home Gateway window, as shown in Figure 55.

Figure 55 Speed Test window

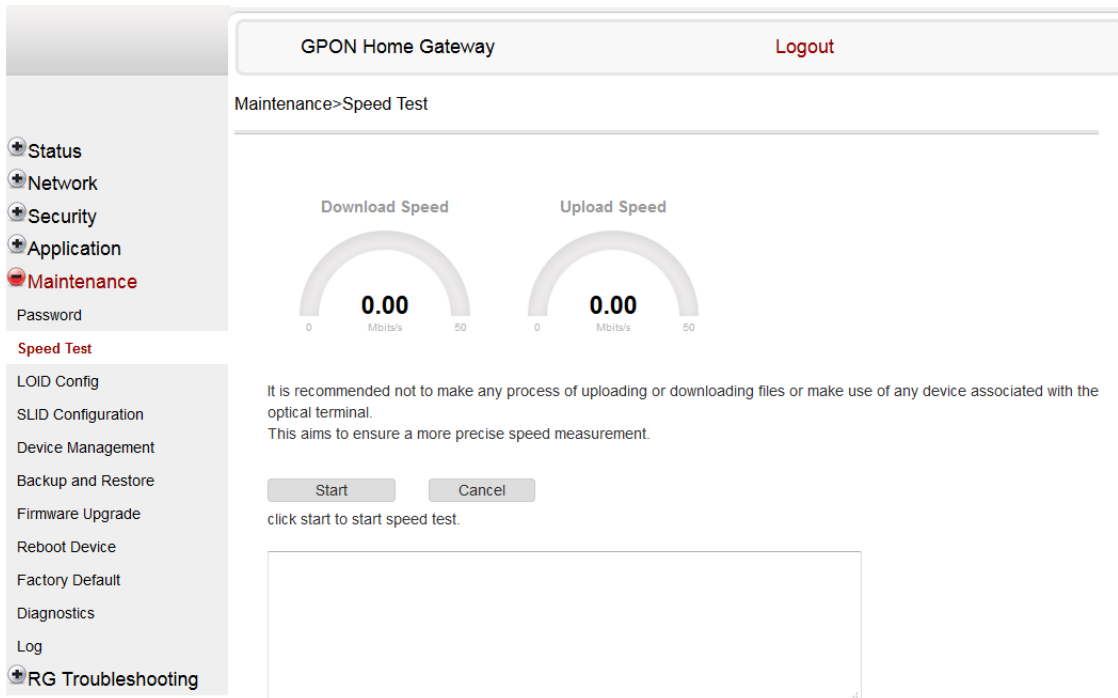

- 
- 2 Click Start to start the speed test.  
Enter the URL for the test server in the pop-up window.
- 
- 3 STOP. This procedure is complete.
-

## Procedure 40 LOID configuration

- 1 Select Maintain > LOID Config from the top-level menu in the GPON Home Gateway window, as shown in Figure 56.

**Figure 56** LOID Config window

Table 47 describes the fields in the LOID configuration window.

**Table 47** LOID configuration parameters

Field	Description
LOID	Type the LOID; the maximum number of characters is 24 If the password is null, this field may be left blank
Password	Type the password; the maximum number of characters is 12

- 2 Configure the LOID.
- 3 Click Save/Apply.
- 4 STOP. This procedure is complete.



## Procedure 41 SLID configuration

- 1 Select Maintain > SLID Configuration from the top-level menu in the GPON Home Gateway window, as shown in Figure 57.

**Figure 57 SLID configuration window**

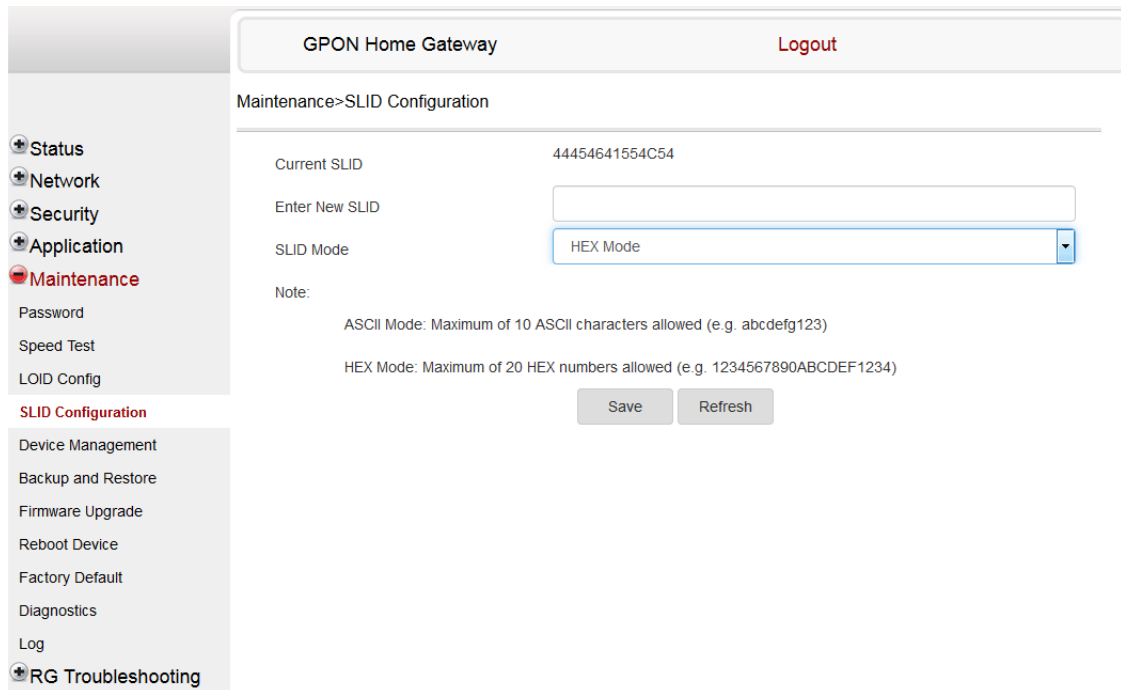

Table 48 describes the fields in the SLID configuration window.

**Table 48 SLID configuration parameters**

Field	Description
Current SLID	Displays the current SLID
Enter New SLID	Enter new SLID
SLID Mode	Choose a SLID mode from the drop-down menu The default is HEX Mode

- 2 Configure the new SLID.

- 3 Click Save.
- 4 STOP. This procedure is complete.

## Procedure 42 Device management

- 1 Select Maintain > Device Management from the top-level menu in the GPON Home Gateway window, as shown in Figure 58.

**Figure 58** Device management window

The screenshot shows the 'GPON Home Gateway' interface. At the top right, there is a 'Logout' button. Below the title bar, the breadcrumb 'Maintenance > Device Management' is visible. On the left side, a navigation menu includes 'Status', 'Network', 'Security', 'Application', 'Maintenance' (highlighted in red), 'Password', 'Speed Test', 'LOID Config', 'SLID Configuration', 'Device Management' (highlighted in red), 'Backup and Restore', 'Firmware Upgrade', 'Reboot Device', 'Factory Default', 'Diagnostics', 'Log', and 'RG Troubleshooting'. The main content area contains two input fields: 'Host Name' (a dropdown menu showing 'CV0028542N0') and 'Host Alias' (a text input field). Below these fields is an 'Add' button. At the bottom of the main area, there is a table with three columns: 'Host Name', 'Host Alias', and 'Delete'. Below the table is a 'Refresh' button.

Table 49 describes the fields in the Device management window.

**Table 49** Device management parameters

Field	Description
Host Name	Choose a hostname from the drop-down menu
Host Alias	Enter an alias for the chosen host

- 2 Configure an alias for a specific host.

- 
- 3 Click Add.
- 
- 4 STOP. This procedure is complete.
- 

### Procedure 43 Backup and restore

- 
- 1 Select Maintain > Backup and Restore from the top-level menu in the GPON Home Gateway window, as shown in Figure 59.

**Figure 59 Backup and Restore window**

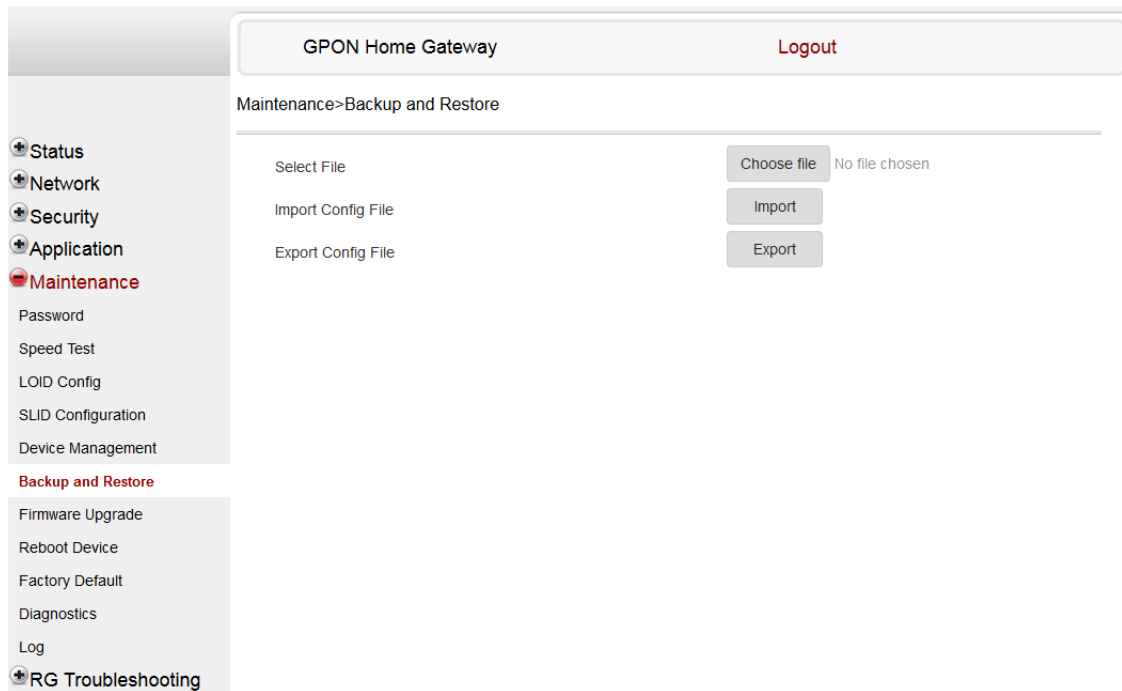

- 
- 2 Click Choose file and choose the backup file.
- 
- 3 Click Import to restore the ONT to the saved backup, or click Export to export the current ONT configuration to the backup file.
- 
- 4 STOP. This procedure is complete.
-

---

## Procedure 44 Upgrade firmware

- 1 Select Maintain > Firmware Upgrade from the top-level menu in the GPON Home Gateway window, as shown in Figure 60.

**Figure 60** Firmware upgrade window

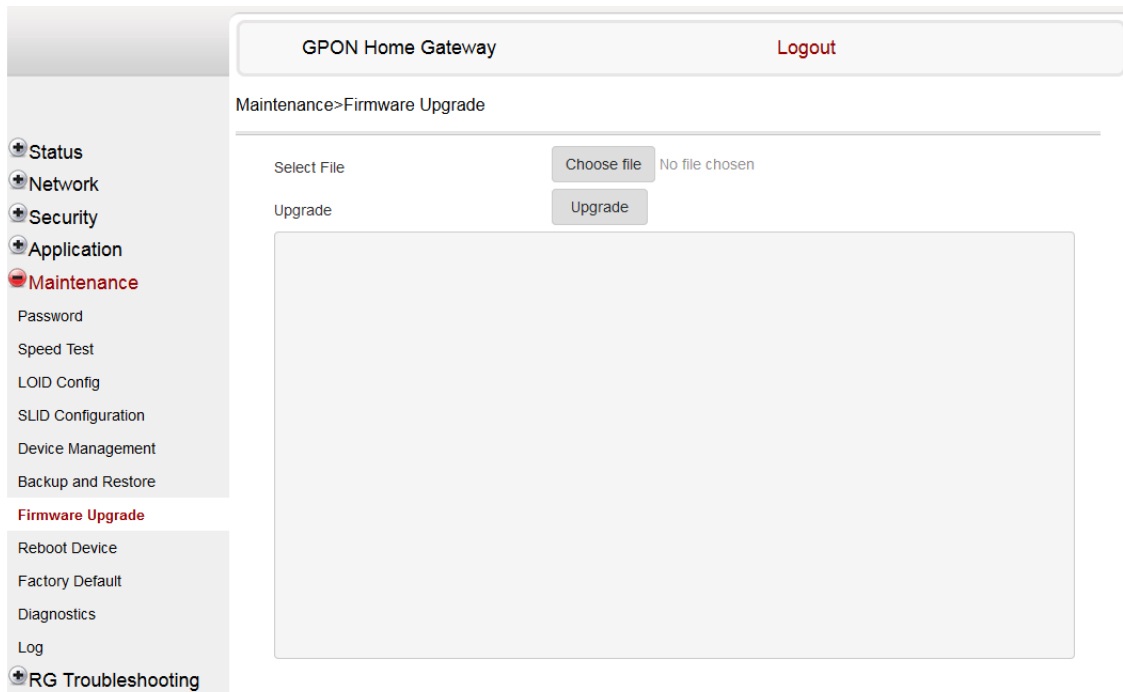

- 2 Click Choose file and choose the firmware file.
  - 3 Click Upgrade to upgrade the firmware.
  - 4 STOP. This procedure is complete.
-

---

## Procedure 45 Reboot ONT

- 1 Select Maintain > Reboot Device from the top-level menu in the GPON Home Gateway window, as shown in Figure 61.

**Figure 61** Reboot window

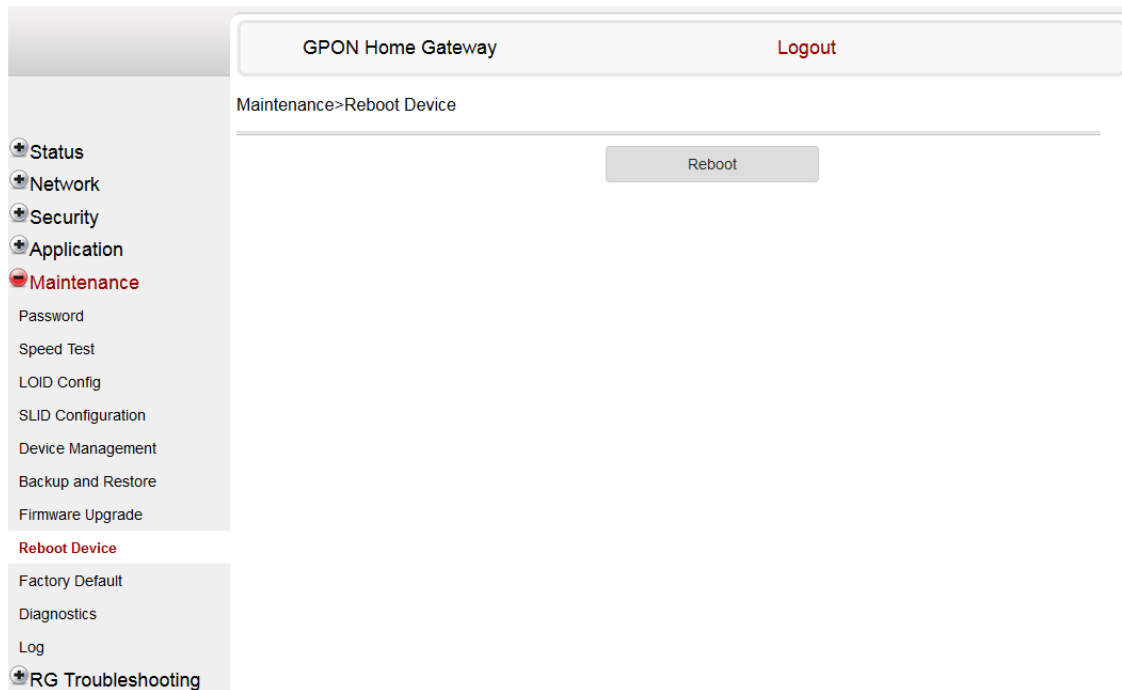

- 2 Click Reboot to reboot the ONT.
  - 3 STOP. This procedure is complete.
-

---

## Procedure 46 Restore factory defaults

- 1 Select Maintain > Factory Default from the top-level menu in the GPON Home Gateway window, as shown in Figure 62.

**Figure 62** Factory default window

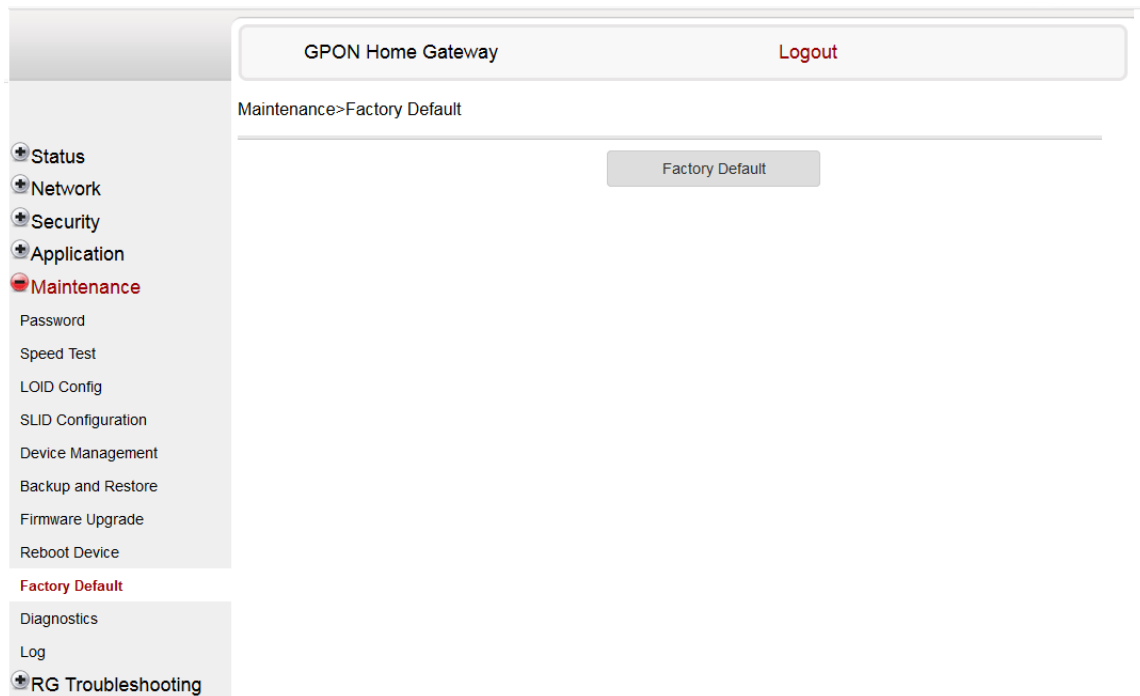

- 2 Click Factory Default to reset the ONT to its factory default settings.
  - 3 STOP. This procedure is complete.
-

## Procedure 47 Diagnose WAN connections

- 1 Select Maintain > Diagnostics from the top-level menu in the GPON Home Gateway window, as shown in Figure 63.

Figure 63 Diagnostics window

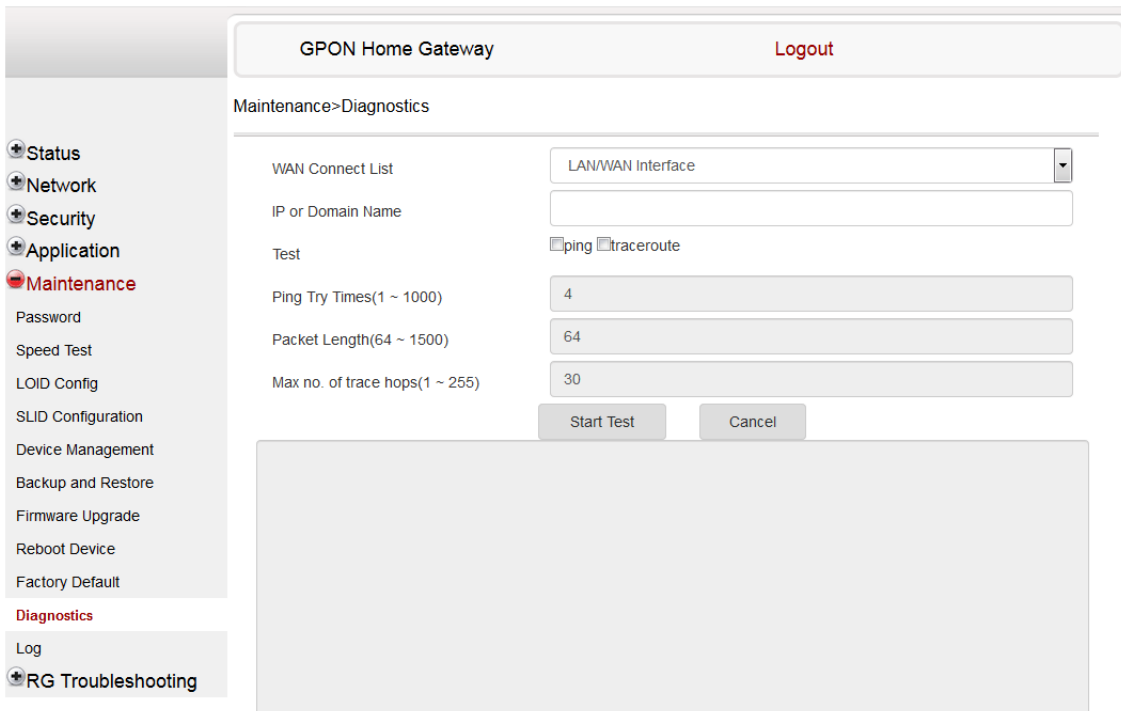

- 2 Choose a WAN connection to diagnose from the drop-down menu.
- 3 Enter the IP address or domain name.
- 4 Select the test type: ping, traceroute, or both.
- 5 Enter the number of ping attempts to perform (1 - 1000); the default is 4.
- 6 Enter a ping packet length (64-1024); the default is 64.
- 7 Enter the maximum number of trace hops (1-255); the default is 30.
- 8 Click Start Test. The results will be displayed at the bottom of the window.

- 9 Click Cancel to cancel the test.
- 10 STOP. This procedure is complete.

## Procedure 48 View log files

- 1 Select Maintain > Log from the top-level menu in the GPON Home Gateway window, as shown in Figure 64.

**Figure 64** Log window

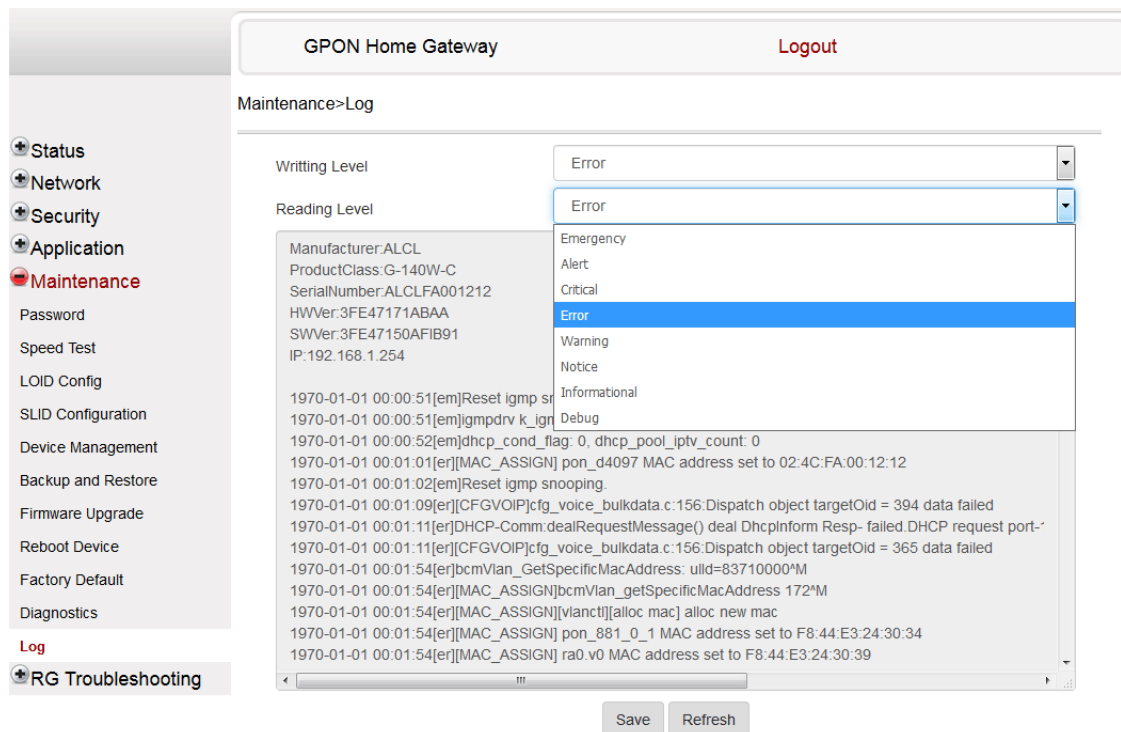



**2** Choose a write level from the drop-down menu to determine which types of events are recorded in the log file:

- Emergency
  - Alert
  - Critical
  - Error
  - Warning
  - Notice
  - Informational
  - Debug
- 

**3** Choose a reading level from the drop-down menu to determine which types of events to display from the log file:

- Emergency
  - Alert
  - Critical
  - Error
  - Warning
  - Notice
  - Informational
  - Debug
- 

**4** The log file is displayed at the bottom of the window.

---

**5** STOP. This procedure is complete.

---

## 8.2.7 RG troubleshooting counters

The Troubleshooting Counters feature enables service providers and end users to monitor the performance of their broadband connection.

Tests are run to retrieve upstream and downstream throughput, latency, and DNS response time. The Troubleshooting Counters window also displays upstream and downstream packet loss and Internet status.

## Procedure 49 Retrieve Residential Gateway (RG) troubleshooting counters

- 1 Select RG Troubleshooting Counters from the left menu in the GPON Home Gateway window.

The RG Troubleshooting Counters window appears; see Figure 65.

**Figure 65** RG Troubleshooting Counters window

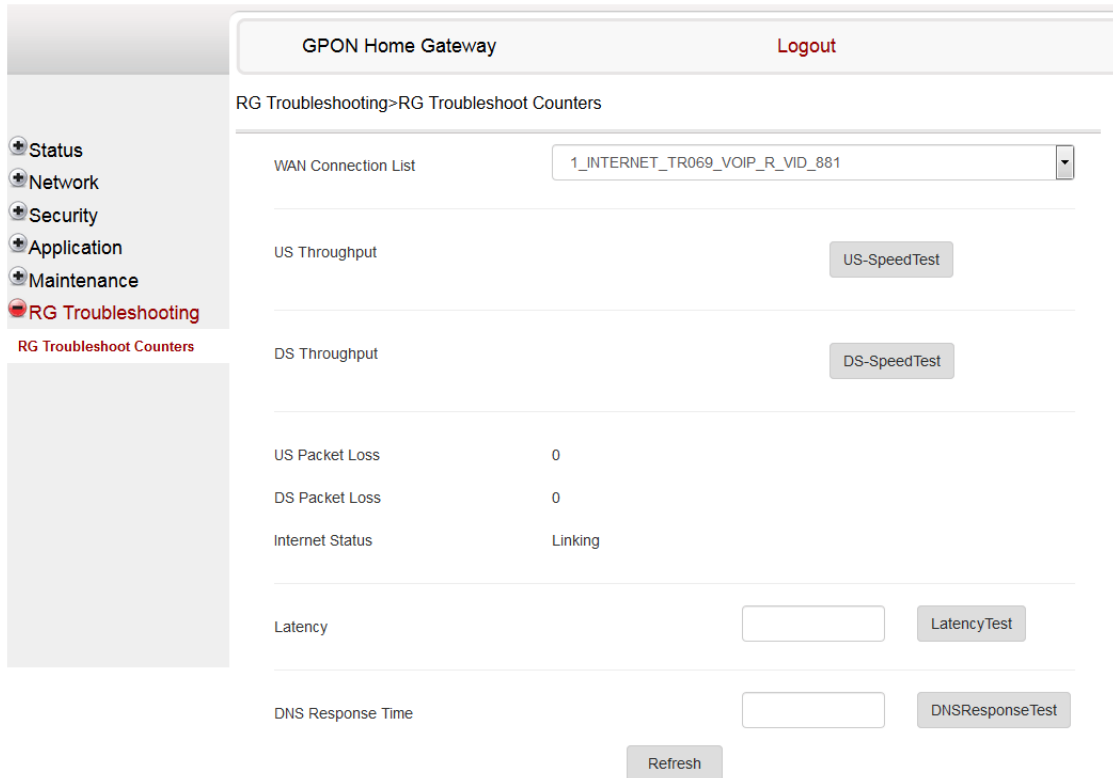

Table 50 describes the fields in the RG Troubleshooting Counters window.

**Table 50** RG Troubleshooting Counters parameters

Field	Description
WAN Connection List	Choose a WAN connection from the list
US Throughput	This test is used to determine the upstream throughput/speed Click US Speed Test to specify the time for the upstream test The default is weekly, performed at idle to a public server
DS Throughput	This test is used to determine the downstream throughput/speed Click DS Speed Test to specify the time for the downstream test The default is weekly, performed at idle to a public server

(1 of 2)

---

Field	Description
US Packet Loss	The number of upstream packages lost
DS Packet Loss	The number of downstream packages lost
Internet Status	Whether the broadband connections is active (UP) or not (DOWN)
Latency	This test is used to determine the lowest round-trip time in milliseconds by pinging the target server multiple times Click Latency Test to specify the time for the test The default is weekly, performed at idle to a public server
DNS Response Time	This test is used to determine the lowest round-trip time in milliseconds by sending a request to the target DNS server Click DNS Response Test to specify the time for the test The default is weekly, performed at idle to a public server

(2 of 2)

---

**2** Configure the test times if desired.

---

**3** Click Refresh to update the data.

---

**4** STOP. This procedure is complete.

---



---

# 9 ONT configuration file over OMCI

## 9.1 Purpose

### 9.2 Supported configuration file types

### 9.3 ONT configuration file over OMCI

## 9.1 Purpose

This procedure describes how to use configuration files over OMCI to configure ONTs. Some advantages include:

- flexibility to change the ONT default behavior by downloading configuration file
- flexibility to update a deployed ONT by downloading updated parameters
- ability to securely download any configuration file to an ONT
- ability to avoid using embedded configuration files in ONT software



**Note** — This feature is supported for use with the 7360 ISAM FX and the 7342 ISAM FTTU.

## 9.2 Supported configuration file types

Table 51 describes the configuration file types that are supported from 7368 ISAM ONT R05.02.00 and later.

**Table 51 Supported configuration files**

File Index	Description	Details	Supported ONTs/DPU
PRE	ONT pre-configuration file	<p>The XML-based PRECONFIG file controls the working mechanics of the ONT for various services. The default behavior of different ONTs may vary based on the factory settings.</p> <p>The pre-configuration file includes the factory default value for the residential gateway.</p> <p>Note: the pre-configuration file does not work with SFU ONTs; therefore, this feature applies only to Residential Gateway ONTs.</p> <p>The pre-configuration file can be used as is, but Nokia provides its customers with the flexibility to customize the pre-configuration file.</p> <p>This pre-configuration file enables operators to change the default behavior by downloading a customized pre-configuration based on customer inputs.</p> <p>This PRE XML file includes a custom OPERID.</p> <p>The Nokia defined index for the PRECONFIG file is: "PRE"</p>	All Nokia GPON and 10 GPON ONT.
CFG	ONT configuration delta file	<p>The XML-based CFG file updates the configurable parameters (the PRE settings) in the existing PRE file of a deployed ONT, where required.</p> <p>This configuration file enables operators to change the deployed behavior by downloading customized updates in the CFG file.</p> <p>This file is used only to modify the parameters in the PRE file; it is not used for service provisioning.</p> <p>No OPERID is required, because the update is based on the OPERID used for the PRE file.</p> <p>The Nokia defined index for the PRECONFIG DELTA file is: "CFG"</p>	All Nokia GPON and 10GPON ONT.
XML	Voice XML file	<p>The Voice XML file provides an alternate method for securely downloading voice parameters from the OLT, rather than using FTP (OMCiv1/OMCiv2) or HTTPS (TR-069). Downloading this file makes the applicable changes in the voice parameters.</p> <p>This file enables operators to change the voice behavior by downloading the updated voice XML file.</p> <p>Nokia recommends using this procedure, rather than embedded voice XML files.</p> <p>The Nokia defined index for the Voice XML file is: "XML"</p>	All Nokia GPON and 10 GPON ONT.

(1 of 2)

File Index	Description	Details	Supported ONTs/DPU
GFT	G.fast-related configuration file	<p>This text-based json script file controls the default behavior of the G.Fast ONT.</p> <p>This file includes the provisioning parameters of the G.fast transports layer; it does not include VLAN or QoS provisioning.</p> <p>While the ONT functions well with the default values; they can optionally be customized.</p> <p>While default values can work in VDSL mode, a download file is required for the device to function as a G.fast ONT.</p> <p>The Nokia defined index for the G.fast file is: "GFT"</p>	Nokia G.fast.

(2 of 2)

## 9.2.1 Filename conventions

Nokia provides the raw configuration files, which must be saved by the operator in a TAR file to be uploaded. TAR file names must be unique.

The filenames of the raw configuration files may not adhere to the naming conventions outlined below. In this case, the files must be renamed to adhere to the naming conventions before the operator generates the TAR file. Filenames are not case-sensitive.

*ABCXXXXVER*

where

*ABC* is the file index type (PRE, CFG, XML, GFT)

*XXXX* is the operator ID

For PRE and CFG, a valid operator ID is required

For XML and GFT, any characters may be used

*VER* is the file version (from 001 to 999)

Note: you cannot update the configuration using two files with the same name.

## 9.3 ONT configuration file over OMCI



**Warning** — Executing the following procedure will trigger the ONT to reboot, which will impact ongoing services.

Use this procedure to configure ONTs using configuration files via OMCI.

---

## Procedure 50 Configuring an ONT using a configuration file via OMCI

---

- 1 Generate the TAR file to be uploaded to the OLT.

Using the raw configuration file(s) provided by Nokia, generate the TAR file as follows:

- i On a Linux platform, rename the raw configuration file to adhere to the naming convention, as described in section 9.2.
- ii Tar the *ABCXXXXVER* raw configuration file:

```
tar -cf ABCXXXXVER.tar ABCXXXXVER
```

Where  
*ABCXXXXVER*  
Is the name of the file created in step i.

This creates two files: *ABCXXXXVER* and *ABCXXXXVER.tar*.

- iii Rename *ABCXXXXVER* to *ABCXXXXVER.org*
- iv Remove the “.tar” extension from *ABCXXXXVER.tar* file.

- 
- 2 Upload the *ABCXXXXVER* TAR file to the /ONT/ directory in the OLT.

A maximum of 250 files can be kept in the OLT file system.

- 
- 3 Using OLT commands, download the TAR file to the ONT.

For OLT commands, refer to the *7360 ISAM FX CLI Command Guide for 100\_320Gbps FD NT and FX NT*, or the *7342 ISAM FTTU Operation and Maintenance Using TL1 and CLI*.

Please note:

- *pri-cfgfile-pland/dnload* or *sec-cfgfile-pland/dnload* can be 1 to 14 characters.
- *pri-cfgfile-pland* and *pri-cfgfile-dnload* should be the same name.

### Examples

Note: X can be 1 or 2 unless specified:

- i If *pland-cfgfileX= Disabled* and *dnload-cfgfileX= Disabled*,  
no file will be downloaded to the ONT.
- ii If *pland-cfgfileX=FILENAME1* and *dnload-cfgfileX= Disabled*,  
FILENAME1 will be downloaded and FILENAME1 will be made active. An ONT reboot is required.
- iii If *pland-cfgfileX=Disabled* and *dnload-cfgfileX= FILENAME2*



---

FILENAME2 will be downloaded and FILENAME2 will be made passive. An ONT reboot is not required.

**iv** If `pland-cfgfileX=FILENAME3` and `dnload-cfgfileX= FILENAME 4`, the OLT reports an error because the filenames are not the same.

**v** Configure equipment interface ... `pland-cfgfile1=XMLXXXXXX1` and `dnload-cfgfile1 XMLXXXXXX1`

Configure equipment interface ... `pland-cfgfile2=XMLXXXXXX2` and `dnload-cfgfile2 XMLXXXXXX2`

Although the OLT permits the above two steps without reporting an error, Nokia does not recommend executing them, because the ONT may exhibit unexpected behavior.

**vi** If `pland-cfgfileX=Auto` and `dnload-cfgfileX= Auto`

The OLT will download the XML file from "sw-ctr-list" (configure equipment ont sw-ctrl)

---

**4** STOP. This procedure is complete.

The ONT will distribute the configuration files to the different services based on the active indication from the OLT and on the Nokia defined index.

The ONT automatically reboots to apply the configuration files. After the ONT reboots and reports the active version, the OLT completes the file download procedure.

Operators must check the committed file from the OLT to verify whether the corresponding file has been applied. If an error occurs, contact Nokia for support.

---



# Customer document and product support



## Customer documentation

[Customer Documentation Welcome Page](#)



## Technical Support

[Customer Documentation Technical Support](#)



## Documentation feedback

[Customer Documentation Feedback](#)

